



中德能源与能效合作
Energiepartnerschaft
DEUTSCHLAND - CHINA

Supported by:



on the basis of a decision
by the German Bundestag

German Sustainable Heating Solutions – Best Practices and Application in China

Sino-German Energy Partnership



Imprint

The study “German Sustainable Heating Solutions – Best Practices and Applicability in China” is published within the framework of the “Sino-German Energy Partnership”. The aim of the partnership is to facilitate a dialogue on political, industrial and regulatory issues of both countries’ energy transitions and to find solutions for common challenges in the energy sector. For China, the National Development and Reform Commission (NDRC) and the National Energy Administration (NEA) are in head the partnership, while the Federal Ministry for Economic Affairs and Energy (BMWi) is in the lead for Germany. The Deutsche Gesellschaft für Internationale Zusammenarbeit (GIZ) GmbH has been commissioned to implement the energy partnership on behalf of BMWi. As a German federal company, GIZ supports the German government in achieving its goals in international cooperations for sustainable development.

Published by

Sino-German Energy Partnership
Tayuan Diplomatic Office Building 2-5,
14 Liangmahe South Street, Chaoyang District
100600 Beijing, P. R. China

c/o

Deutsche Gesellschaft für Internationale Zusammenarbeit (GIZ) GmbH
Torsten Fritsche
Köthener Str. 2
10963 Berlin, Germany

Project Management:

Yin Yuxia, Ma Qiongying, Maximilian Ryssel, Yang Neng
Deutsche Gesellschaft für Internationale Zusammenarbeit (GIZ) GmbH

Study Coordination:

Wolfgang Eichhammer, Fraunhofer Institute for Systems and Innovation Research ISI

Authors:

Wolfgang Eichhammer, Markus Fritz
Fraunhofer Institute for Systems and Innovation Research ISI

Martin Pehnt, Sara Fritz, Michael Nast
ifeu – Institute for Energy and Environmental Research IFEU

Jan Steinbach, Jasmin Henrich, Eftim Popovski
Institute for Resource Efficiency and Energy Strategies (IREES)

Special thanks go to Mr. Li Wenkai and Mr. Zhao Wenying from China Electric Power Planning and Engineering Institute (EPPEI) for support -ing this report.

Recommended citation:

Fraunhofer ISI.; IFEU; IREES (2019): German Sustainable Heating Solutions – Best Practices and Applicability in China. Karlsruhe/Heidelberg

Cover image: BMWi

© Beijing, November 2019

This report in its entirety is protected by copyright. The information contained was compiled to the best of our knowledge and belief in accordance with the principles of good scientific practice. The authors believe the information in this report is correct, complete and current, but accept no liability for any errors, explicit or implicit. The statements in this document do not necessarily reflect the client’s opinion.

Contents

1.	Executive summary	5
2	Introduction: strategies for sustainable heating	8
2.1	Objectives of the study	8
2.2	Status quo of Germany’s heating and cooling sector	9
3	Approach for the selection of sustainable heating solutions	12
4	Selection of German sustainable heating solutions for China	14
4.1	Small solid biomass stoves with heavily reduced particle emissions	14
4.2	Air source heat pump system in combination with a PV module and an electric heater for domestic hot water	18
4.3	Ground source heat pump (GSHP)	25
4.4	Hybrid photovoltaic-thermal collector in combination with heat pumps	31
4.5	Waste water heat recovery systems	35
4.6	Bioenergy villages	40
4.7	Large solar collector fields	46
4.8	Geothermal district heating	51
4.9	Combined heating and cooling grid with gas CHP, heat pumps and thermal storages	59
4.10	Industrial excess heat recovery	65
5	Discussion and conclusion	70
6	List of figures	72
7	List of tables	73
8	List of abbreviations	74
9	Bibliography	75

Foreword

Dear readers and friends,

Global warming has become the predominant challenge of our time. Droughts, flooding, and extreme temperatures are calling into question our century-long dependency on fossil fuels. In the energy sector, climate change has been the main driver for Germany's and China's energy transitions. We have achieved a lot in the last two decades, primarily in the electricity sector. Today, renewables account for more than 40% of Germany's net electricity production and China boasts the world's largest renewable installed capacity, more than 700 GW. However, our actions are insufficient. We start looking beyond electricity and towards another major energy consumer: the heating sector.

Space and process heating account for around 50% of total energy consumption. However, the sector is also much more difficult to decarbonise. A successful heating transition requires solutions that are technologically, economically and – probably most importantly – socially acceptable for millions of people who depend on a reliable heat supply during winter. As part of its energy transition, the German Federal Government has set itself the target to reach carbon-neutrality in all sectors by 2050. For heating, Germany follows a dual-track approach by increasing the share of renewable heating and fostering energy efficiency standards in buildings. Hence, Germany's Renewable Heating Act sets minimum requirements for the compulsory utilisation of renewable heating technologies in new buildings. The Energy Saving Act sets limits for new building's maximum primary energy consumption. As a result of these two policies and different (financial) support programmes, sustainable and renewable heating technologies are deployed in approximately 50% of new buildings in Germany today. Recently, Germany has decided to introduce carbon prices to the heating sector. This will certainly further spur the heating transition.

China has also placed the heating transition at the heart of the energy revolution. China is striving for an ambitious 70% clean heating share by 2021. This is of utmost importance not only for tackling climate

change, but furthermore for reducing air pollution in the country's mega cities. China's Energy Revolution follows the principle of "Four Revolutions and One Cooperation". The latter implies exchange and learning through international cooperation. The Sino-German Energy Partnership between the German Federal Ministry for Economic Affairs and Energy (BMWi), the National Development and Reform Commission (NDRC) and the National Energy Administration (NEA) serves to build bridges between both countries' governments, industry and academia, and finding solutions to common challenges in the energy sector.

For many years, sustainable heating has been one of our partnership's focal topics. Up to now, we have mainly focused on policy instruments for the heat transition. In 2019 however, we added an exchange of best-practice heating solutions. This comprehensive report highlights 10 German best-practice solutions and discusses their applicability for China. It is the result of a research project conducted by experts from Fraunhofer Institute for Systems and Innovation Research ISI, ifeu - Institute for Energy and Environmental Research and the Institute for Resource Efficiency and Energy Strategies (IREES) with the support of our partners from the China Electric Power Planning and Engineering Institute (EPPEI). I would like to express my sincere gratitude to all involved experts and partners for their support during this project. I hope that this study will contribute towards finding solutions for a future worth living, and serve as an inspiration for further Sino-German cooperation in the heating sector.



Markus D. Delfs

Head of Cluster Sustainable Transition – Investment & Infrastructure, Energy, Mobility and Waste
Deutsche Gesellschaft für Internationale Zusammenarbeit (GIZ) GmbH

1. Executive Summary

This report identifies relevant German best practices in the field of sustainable heating for the transformation of China's heating and cooling market. The focus is on implemented, innovative, sustainable and integrated heat generation and heat supply solutions, taking into account local conditions (resources) and economic framework conditions (business models). The study draws from existing and implemented solutions and experiences in Germany's heating sector. The discussed solutions have two objectives:

- Reduce the severe local pollution linked to the heavy use of coal and other fossil fuels for heating purposes;
- Mitigate climate change.

The focus is on solutions that can be implemented now and over the coming decade. However, the technologies discussed in this report should also support the long-term climate targets for 2050, which require substantial greenhouse gas mitigation efforts by China and Germany. An exchange of suitable solutions and strategies that satisfy both objectives is therefore of utmost importance. To select sustainable heating solutions for discussion in the Chinese context, in a first step, a long list of 20 sustainable heating technologies was identified, described and discussed with experts from the China Electric Power Planning and Engineering Institute (EPPEI). The long list of selected heating solutions contains heating (partly: cooling) technologies and systems, which contribute to a clean heating strategy combining low pollutant emissions and low greenhouse gas (GHG) emissions. Important selection criteria were the following:

- The solutions show a certain degree of innovativeness in combination with promising growth opportunities and a good market diffusion. Nevertheless, innovative solutions were also included that may be interesting looking ahead to 2030 and beyond.
- Standard solutions, such as gas and oil condensing boilers, were not included in the list due to their climate impact.
- Clean coal technologies (i.e. coal-based technologies with low local emissions, such as particulates), were not included as they continue to generate a strong impact on the climate. Thus, the technologies chosen aim at double benefits for local and global emissions.
- The solutions for which Germany lacks experience (e.g. straw boilers) were not included in the list.

The list was divided into three groups, covering a range from simple technologies for individual use to complex solutions for urban areas: decentralised heating systems, local district heat (DH), and large DH.

Based on the long list, a shorter list of 10 sustainable heating strategies was selected in discussion with experts from EPPEI. These 10 technologies are marked in bold in the table below and are analyzed in detail in this report. They build the basis for a stakeholder workshop taking place end of November 2019 in Beijing.

Sustainable heating solutions discussed in the report

No	Decentralised heating systems	Application
1	Small solid biomass stoves with heavily reduced particle emissions	R
2	Air source heat pump system in combination with a photovoltaic (PV) module and a domestic hot water heater (DHW)	R, U
3	Ground source heat pump (GSHP)	R, U
4	Fuel cell micro combined heat and power (CHP) with a peak load gas boiler	R
5	Pellet boiler (emission optimised) w/ solar thermal for DHW	R
6	Pellet boiler (emission optimised) with PV space heating + DHW	R
7	Bio-hybrid heat pump with solid biomass boiler for peak hours	R, U
8	Heat pump with ice storage and solar/air absorber (+PV)	U
9	Hybrid photovoltaic-thermal collector (PVT) in combination with a heat pump	R, U

No	Local district heat (DH)	Application
10	Biogas CHP from manure	R
11	Waste water heat recovery systems	U
12	Gas CHP with electric a heat pump	U
13	Cold DH with decentralised heat pumps (5GDHC)	R, U
14	Biomass boiler with solar thermal incl. seasonal storage	R
No	Large DH (transformation)	Application
15	Large heat pump (river water, waste heat from metro)	U
16	Large solar collector fields	U
17	Geothermal district heating	U
18	Combined heating and cooling grid with gas CHP, heat pumps and thermal storage	R, U
19	Industrial excess heat recovery	U
20	Gas CHP with methane produced from renewable energy sources (power-to-gas)	U

* (R = rural/ U = urban)

The figure below characterises the ten selected sustainable heating solutions according to the following five criteria:

- Greenhouse gas reduction potential:** all of the selected solutions have a substantial GHG reduction potential which makes them interesting for the time horizon of 2030 and 2050. Nevertheless, differences occur where substantial amounts of electricity are involved for auxiliary aggregates, e.g. for the running of heat pumps or of fluid circulation pumps etc. Here, the electricity mix has a major impact on the performance. Using the present power mixes in Germany and China, which include high shares of coal-based generation, the GHG advantage of some of these technologies is still limited. However, with the coal phase-out ahead in Germany and further penetration of renewables in the power mix, the full GHG reduction potential of those technologies could be realised.
- Local pollutant reduction potentials:** most of the sustainable heating solutions listed show a very good local pollutant reduction potential. However, this is only partly the case for solutions relying on biomass. For example, particle and NOx emissions are highly dependent on user behavior. For most of the other technologies no local emissions occur. However, especially for those solutions requiring a steady power input, their life-cycle emissions depend on the (local) power mix. Local pollutant reduction potentials are hence similar to GHG emission reduction potentials (s. above) and depend on local

emissions as well as on pollutant reduction measures in local power plants.

- Resources:** Under resources we group issues such as the non-sustainable use of abiotic or biotic resources including water (ground and surface water) and land area. Here, the picture is more mixed across the different technologies. Biomass in particular is a limited and contested resource as other sectors (i.e., transport and industry) strive to increase their biomass shares in their energy consumption. For other technologies (e.g. solar thermal collector fields) land use is an issue. Geothermal ground water utilisation could be limited by seismic risks.
- Total costs:** Total costs, expressed in LCOH (levelised cost of heat), are partly higher than those of standard heat generation technologies (up to 30-50% higher). It is important to underline, however, that the absolute costs cannot directly be compared between China and Germany. A cost analysis should be refined in more detailed studies for the Chinese context. In addition, future cost degression will most likely further lower unit costs on a global level.
- Market diffusion:** Half of the technologies listed are already in some stage of market diffusion (e.g. reduced emission biomass) while others, such as the more complex combinations of PVT with heat pumps, are still in their infancy or in an intermediate stage (solar thermal collector fields or deep geothermal). However, all the technologies listed attract an increasing market demand. Future cost degression might even further spur their development.

Cross-cutting characterisation of the ten selected sustainable heating solutions (green: very positive – orange: challenges to be considered)

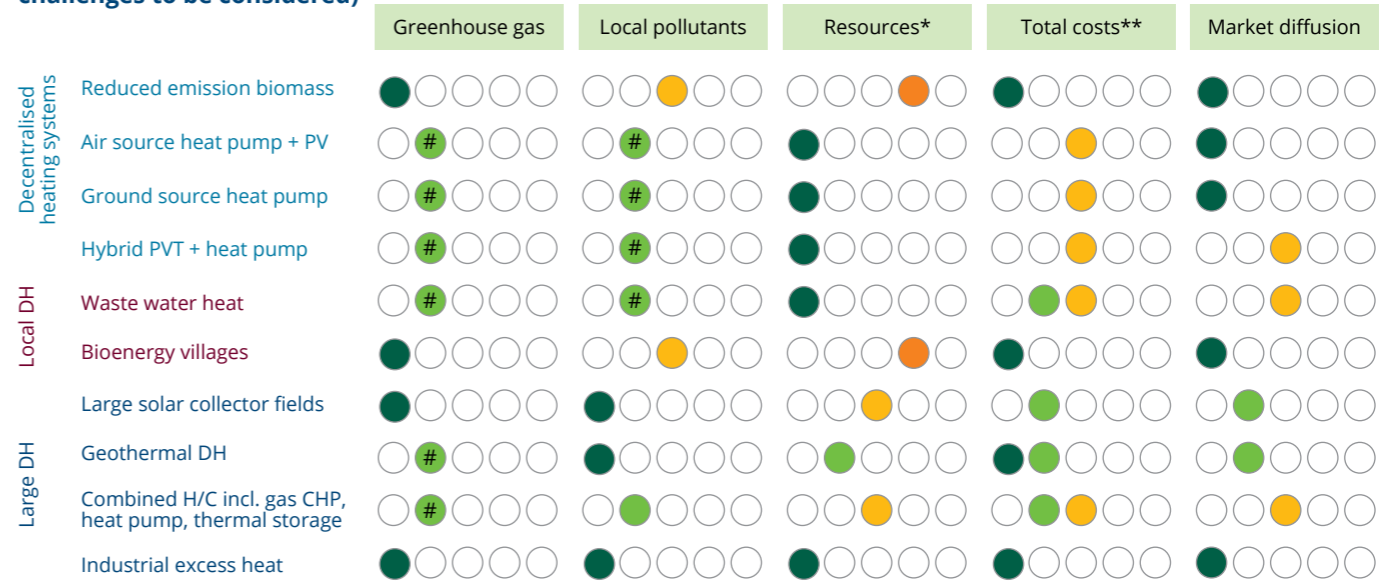

Notes:
 * non-sustainable use of abiotic or biotic resources incl. water and surface area
 ** LCOH (levelised cost of heat), compared to standard heat generation technology
 # depending on electricity mix

There are a number of trends and policy instruments which will strongly impact and spur the demand for sustainable heating solutions. Next to decarbonisation and pollutant emission reduction, this includes (see figure below):

- Hybridization of technologies (particularly combinations with heat pumps or thermal storage);
- Sector coupling (i.e. the heat sector providing flexibility to the power sector, which is more and more important due to high shares of variable

renewable energy sources) and shifting towards the fifth generation of district heating systems offer large potentials for innovative heating solutions;

- Low exergy (i.e. shifting towards lower temperatures in heating systems and distribution);
- Finally, digitalization and automation open new avenues for sustainable heating technologies, which contribute to both local pollution and GHG reductions. In the mid-term, a full decarbonization of the power sector will further enhance these potentials.

Trends for the future of sustainable heating

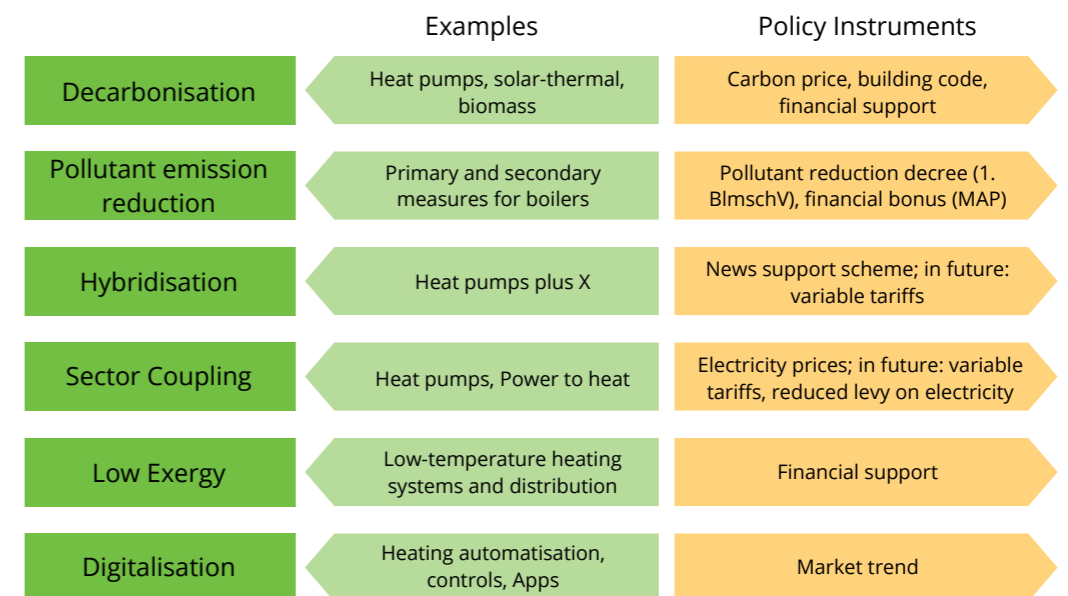

Source: own illustration

2 Introduction: strategies for sustainable heating

2.1 Objectives of the study

In view of China’s progressive urbanisation and increasing prosperity, the country’s energy demand for space heating and domestic hot water are constantly increasing. Today, 63% of heat is generated by combined heat and power (CHP) plants (mainly based on coal) and 36% by coal and gas boilers. Coal is thus also considered the dominant energy source for heat generation in the medium term. Coal is largely used for electricity generation, although renewables, such as wind and solar, could attain a market share of 9% in 2018. Thus, the use of coal in the heating sector largely contributes to the greenhouse gas effect, which leads to steadily rising temperatures on earth.

Against the background of the serious air pollution in China’s large cities, which is partly due to coal combustion, China’s authorities are increasingly trying to promote alternative heating technologies. For example, coal consumption for heat disposal in northern China is to be reduced by 150 million tonnes per year by 2021. To this end, China is focusing on “clean” energies (in addition to solar thermal energy, geothermal energy and biomass, especially natural gas), on the use of electric boilers and heat pumps (keyword: power-to-heat) and on the integration of industrial waste heat sources into the district heating supply.

Against this backdrop, the aim of the present study is to identify and prepare relevant German best practices in the field of sustainable heat generation and supply, heat concepts and technologies (“heat solutions”) for the sustainable transformation of China’s heating and cooling market.

This report identifies relevant German best practices in the field of sustainable heating for the transformation of China’s heating and cooling market. The focus is on implemented, innovative, sustainable and integrated heat generation and heat supply solutions, taking into account local conditions (resources) and economic framework conditions (business models). The study draws from existing and implemented solutions and experiences in Germany’s heating sector. The discussed solutions have two objectives:

- Reduce the severe local pollution linked to the heavy use of coal and other fossil fuels for heating purposes;
- Mitigate climate change.

The key objective is to present solutions that can be applied now and in the course of the next decade. However, the technologies discussed in this report should also support the long-term climate targets for 2050, which require substantial greenhouse gas mitigation efforts in both China and Germany. The exchange regarding suitable solutions and strategies that satisfy both objectives is therefore of uttermost importance.

The report is divided into the following parts: this chapter provides an introduction and brief overview of the status quo of Germany’s heating sector. Chapter 3 describes the approach for the selection of sustainable heating technologies. Chapter 4, the core of the report, analyses the ten selected sustainable heating solutions in detail and discusses their applicability in the Chinese context. Chapter 5 draws conclusions from the study, which will be further substantiated through a stakeholder workshop in November 2019.

2.2 Status quo of Germany’s heating and cooling sector

The energy demand used for heating in buildings reveals the importance of sustainable heating technologies and energy efficiency measures in the German energy transition. Final energy consumption for heating supply – space heating and hot water – accounts for about 31% of total final energy consumption in Germany (Figure 1). Compared to the energy demand for heating purposes, space cooling is negligible, despite an increase in installation rates for air-conditioning systems due to high summer temperatures in recent years. Building energy efficiency poses an additional challenge to Germany’s heat transition. Two thirds of the building stock was built before 1979 without any energy efficiency performance standards being in effect (Figure 2).

Sustainable heating solutions are suitable for buildings that utilise low temperature heat distribution systems. Such systems pose additional requirements for limiting the heat loss via the building envelope. This means that successful dissemination of these technologies depends on energy efficiency measures in existing buildings, such as the insulation of external walls, roofs and the installation of energy-efficient windows. In Germany, over 50% of roofs or upper floor areas of the old building stock have already been retrofitted. In the case of external walls, 20 – 32% have been retrofitted, with the proportion of subsequent renovation decreasing as expected with younger building age, due to lower repair rates and thermal insulation already installed during the construction of the building [2].

Figure 1: Final energy consumption by end-uses in Germany 2017

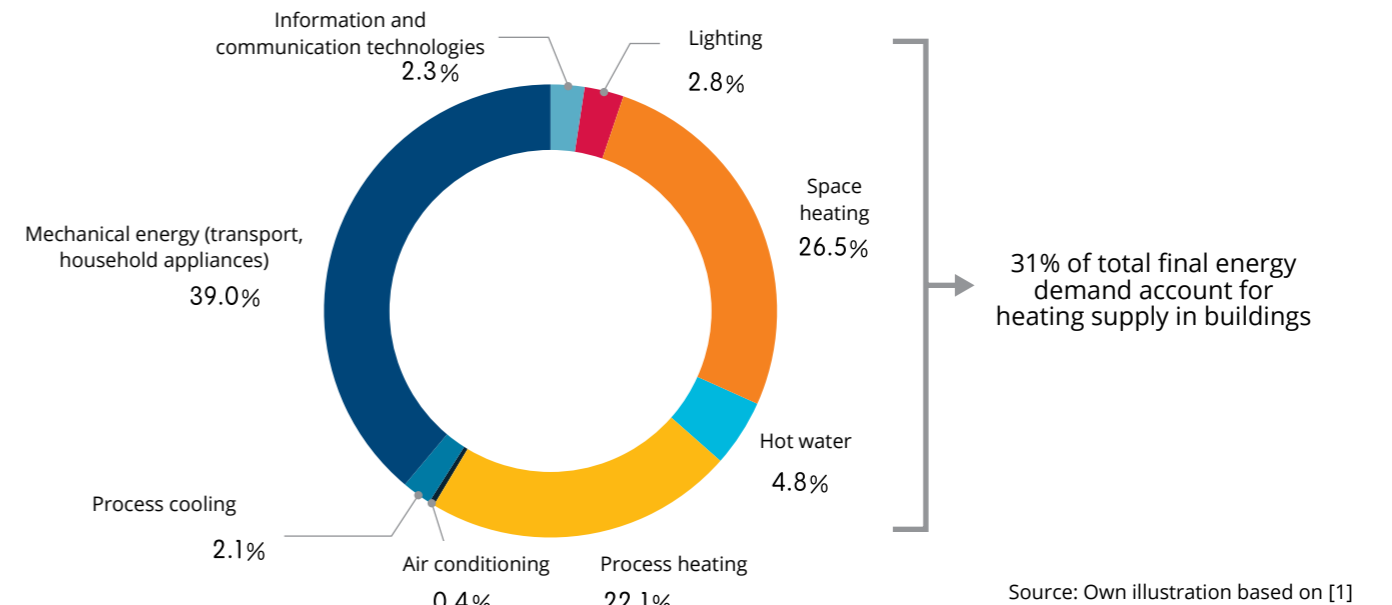
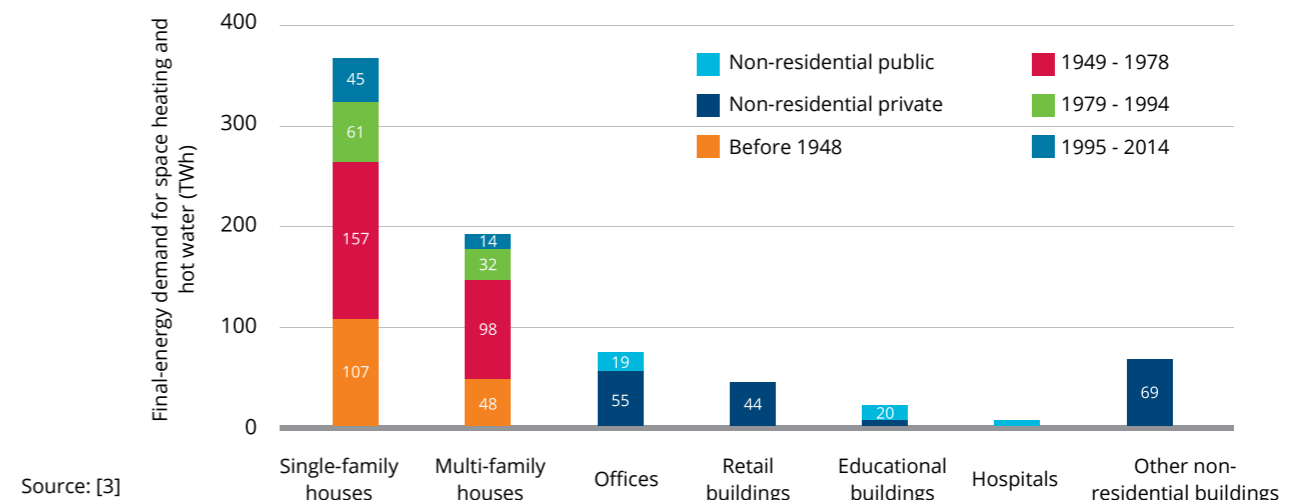
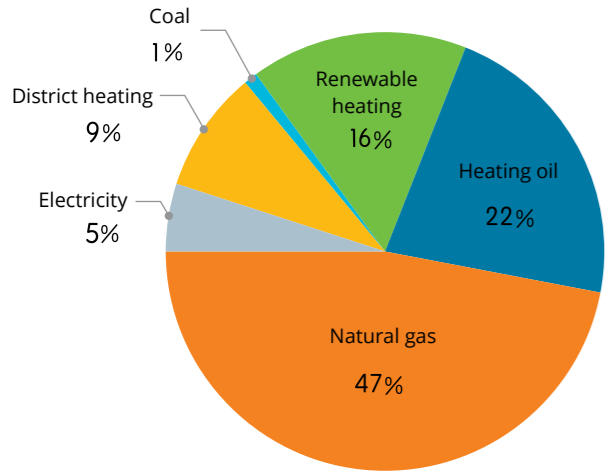

Figure 2: Final energy demand by building type and building category



Space heating and hot water is mainly provided by gas boilers in Germany. Gas boilers cover 47% of final energy demand for heating followed by heating oil with 22% (Figure 3). District heating is mainly relevant in large cities covering 9% of final energy demand. Renewable heating accounted for 16% of final energy demand

Figure 3: Final energy demand for heating by energy carrier in 2018



Source: Own depiction IREES based on [1]

The policies in Germany for sustainable heating and cooling aim at an almost full decarbonisation of the heating and cooling sector (Figure 4). The main policies

Figure 4: GHG emissions of buildings and targets in Germany until 2050

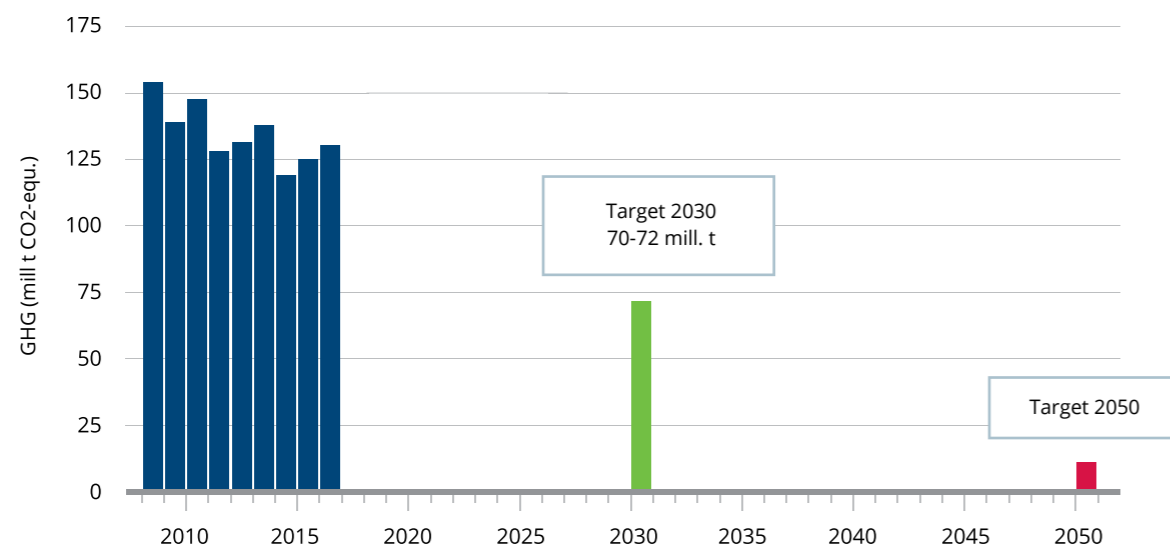

Source: adapted from [5]

to support sustainable heating and energy efficiency measures in buildings are financial support schemes with investment grants and regulation concerning efficiency

for heating in 2018. Biomass makes up about 90% of renewable heating. Single biomass stoves, often used as additional heating systems, make the large majority of biomass generation.



@Shutterstock 726913807, Eskoma

standards of buildings and use obligations for renewable heating (RES-H) installations (Figure 5).

Figure 5: Main federal policy instruments supporting sustainable heating in Germany up to 2019

	Financial support	Regulation / taxation
RES-H	Market Incentive Programme Investment grants, soft loans for RES-H generators	Renewable Heat Act obligation to cover a certain share of heating and cooling demand by RES in new and public buildings
Energy efficiency	KfW Energy-Efficient REfurbishment/ Construction Low-interest loans/repayment bonus for energy efficient buildings Support depends on resulting primary energy demand	Energy Saving Ordinance Regulates maximum primary energy demand of new and existing buildings U-Values for building components
Other energy sectors	Renewable Energy Act / CHP act Feed-tariff for RES-E Bonus for heat from CHP plants	Energy Tax Act Consumption tax on fossil fuels, increases economic efficiency of RES-H generation

Furthermore, several information programmes at the federal, state and municipal levels aim at increasing the market shares of sustainable heating technologies. Amongst others, support for energy advice, obligatory energy performance labelling of existing heating systems and long-term renovation roadmaps are important policies. With regard to sustainable heating solutions in district heating networks, the Combined Heat and Power Act and the support programme “District Heating 4.0” are the most relevant policy schemes.

The further development of support schemes is justified by mandatory energy saving and GHG emission reduction targets. Within the framework of the German Energiewende (energy transition) and the Climate Action Plan, ambitious medium- and long-term targets have been adopted for the heating sector [4]:

- reduction of final energy demand for heating in buildings by 20% in the period from 2008 to 2020,
- increase of renewable energy sources for heating and cooling to 14% by 2020,
- reduction of non-renewable primary energy demand in buildings by 80% in the period from 2008 to 2050,
- reduction of GHG emissions of the building sector by 40% until 2030 compared to 1990.

The new Climate Programme 2030 of the German government published in October 2019 foresees an integration of all support programmes for energy efficiency measures and sustainable heating in one scheme. The new programme will see an additional 840 million € and add to the 2.3 billion € that have already been made available in via KfW (Germany’s state-owned development bank) programmes and the Market Incentive Programme (MAP). Specific subsidies for exchanging old heating systems with renewable heating installations such as heat pumps, biomass boilers and solar thermal

installations will be significantly increased. Subsidies will also be provided for natural gas condensing boilers that are “renewable ready”. In addition, a new tax credit support scheme will be introduced for owner-occupied buildings. Further measures include:

- In order to accelerate the heating transition, new installations of heating oil boilers – that are not combined with renewable heating solutions – will be prohibited from 2026 onwards. By integrating the Renewable Heat Act and the Energy Saving Ordinance into a new “Building Energy Law”, German policymakers are following an approach to further integrate energy efficiency and sustainable heating policies.
- The Climate Programme 2030 published in September 2019 adopts a CO₂ price for the utilization of fossil fuels in the heating and transport sectors. The CO₂ price will start at 10 €/t CO₂ in 2021, equal to a price increase of about 4% on natural gas end consumer prices. The CO₂ price scheme will be implemented as a cap-and-trade system similar to the Emissions-Trading-System (EU-ETS) for industry. However, it is already clear that the measures published in September are not enough to reach the 2030 climate targets. Therefore, additional measures are under evaluation. For those measures, it is assumed that CO₂ prices will increase to 120 EUR/tCO₂ by 2030.
- Until 2038, all lignite and hard coal power plants will be phased out; the Coal Phase-Out Act is expected to be enacted in 2019 and will provide a regulatory and economic framework for the phase-out of hard coal power plants; for lignite power plants, individual phase-out schedules will be negotiated. This has large consequences for large district heating systems which will have to replace waste heat from coal CHP by renewable heating sources.

3 Approach for the selection of sustainable heating solutions

To select sustainable heating solutions for discussion in the Chinese context, in a first step, a long list of 20 sustainable heating technologies was identified, described and discussed with experts from China Electric Power Planning and Engineering Institute (EPPEI). The long list of selected heating solutions contains heating (partly: cooling) technologies and systems, which contribute to a clean heating strategy combining low pollutant emissions and low greenhouse gas (GHG) emissions. Important selection criteria were the following:

- The solutions show a certain degree of innovativeness in combination with promising growth opportunities and a good market diffusion. Nevertheless, some more innovative technologies were included, which might become relevant in a perspective of 2030 and beyond.
- Standard solutions, such as gas and oil condensing boilers, were not included in the list due to their climate impact.
- Clean coal technologies (i.e. coal-based technologies with low local emissions, such as particulates), were not included as they continue to generate a

strong impact on the climate. Thus, the technologies chosen, aim at double benefits for local and global emissions.

- The solutions for which Germany lacks experience (e.g. straw boilers) were not included in the list.

The long list has been divided into three main groups, spanning a range from simpler technologies for individual uses to more complex large-scale solutions, in particular for urban areas:

- Decentralised heating systems (Table 1)
- Local district heat (DH) (Table 2)
- Large DH (transformation) (Table 3)

The long list of 20 sustainable heating technologies is described in more detail in Annex 1. Based on the long list, a shorter list of 10 sustainable heating strategies was selected in discussion with experts from EPPEI. These 10 technologies are marked in Table 1 to Table 3 in bold and are analyzed in detail in the corresponding sections of chapter 4. They build the basis for a stakeholder workshop end of November 2019 in Beijing.

Table 1: Decentralised sustainable heating systems

No	Decentralised heating systems	Application
1	Small solid biomass stoves with heavily reduced particle emissions (see section 4.1)	R
2	Air source heat pump system in combination with a photovoltaic (PV) module and a domestic hot water heater (DHW) (see section 4.2)	R, U
3	Ground source heat pump (GSHP) (see section 4.3)	R, U
4	Fuel cell micro combined heat and power (CHP) with a peak load gas boiler	R
5	Pellet boiler (emission optimised) w/ solar thermal for DHW	R
6	Pellet boiler (emission optimised) with PV space heating + DHW	R
7	Bio-hybrid heat pump with a solid biomass boiler for peak hours	R, U
8	Heat pump with ice storage and a solar/air absorber (+PV)	U
9	Hybrid photovoltaic-thermal collector (PVT) in combination with a heat pump (see section 4.4)	R, U

Table 2: Local district heat (DH)

No	Local district heat (DH)	Application
10	Biogas CHP from manure	R
11	Waste water heat recovery systems (see section 4.5)	U
12	Gas CHP with electric a heat pump	U
13	Cold DH with decentralised heat pumps (SGDHC)	R, U
14	Biomass boiler with solar thermal incl. seasonal storage (see section 4.6)	R

Table 3: Large district heating (transformation)

No	Large DH (transformation)	Application
15	Large heat pump (river water, waste heat from metro)	U
16	Large solar collector fields (see section 4.7)	U
17	Geothermal district heating (see section 4.8)	U
18	Combined heating and cooling grid with gas CHP, heat pumps and thermal storage (see section 4.9)	R, U
19	Industrial excess heat recovery (see section 4.10)	U
20	Gas CHP with methane produced from renewable energy sources (power-to-gas)	U



4 Selection of German sustainable heating solutions for China

The following sections describe the solutions and systems selected in chapter 3 with respect to their technological approach, economic and environmental performance, but also business models or framework conditions which made the evolution of the respective technologies possible.

The aim is not to give an exhaustive overview over all developments in the German heating market, but to review some technologies in detail, particularly solutions that might function within the Chinese context. The structure of this chapter follows the order described in chapter 3, from small decentralised solutions over technologies for district heating to large urban heat infrastructures.

4.1 Small solid biomass stoves with heavily reduced particle emissions

Solid biomass accounts for more than 90% of renewable heating in Germany [1]. In particular log wood stoves have become very popular, allowing the combustion of log wood (and also other solid fuels, preferably with climate neutral carbon from biomass, such as wood briquettes). It is estimated that almost every fourth household in Germany is completely or partially heated with wood.

emissions of these boilers which, especially if operated by inexperienced or untrained users (using wet wood, wrongly stoking, wrong dosage of air etc.), can lead to significant emission levels.

Therefore, products have been developed to solve this problem through primary (design of the boiler chamber, use of heat storage materials, etc.) and secondary measures as well as electronic control of air and fuel supply.

However, concerns have been raised about the particle

Application	mainly rural buildings or buildings with decentralised heating
Target group/ customers:	mainly private customers
Advantages	<ul style="list-style-type: none"> combines carbon-neutral fuel with reduced particle emissions, low fuel costs of primary boiler/stove.
Challenges	<ul style="list-style-type: none"> depends on user behaviour certain devices require an electricity connection or maintenance, depending on the technology
Costs	<ul style="list-style-type: none"> investment in Germany for a typical 5 kW emission reduced biomass stove: 2,000-4,000 € including installation without chimney; in the case of a filter ret-rofit: around 1,500 €, levelised cost of heating (LCOH): 3-7 ct€/kWh depending on the full-load hours.
Specific CO₂ emissions	20-40 g/kWh



@Shutterstock 102111826, tchara

Technology description

Small biomass stoves with reduced particle emissions are based on two alternative approaches:

A) Stoves with primary reduction measures. Stoves and boilers which already have reduced emission levels are based on a combustion chamber with an optimised design which includes, for instance, an optimised thermal storage using a chamotte (which stores the heat and leads to more constant combustion conditions); or features an **optimised combustion process**, e. g. through post-combustion achieved by recirculating the exhaust gas through the flame. These so-called twin-fire stoves already achieve very good emission levels due to the second combustion, which significantly reduces the unburnt carbon content, and due to the mass force effect by the cyclonic effect in the exhaust gas routing.

Figure 6: Air and exhaust gas flow in a twin-fire oven with optimised particle emissions

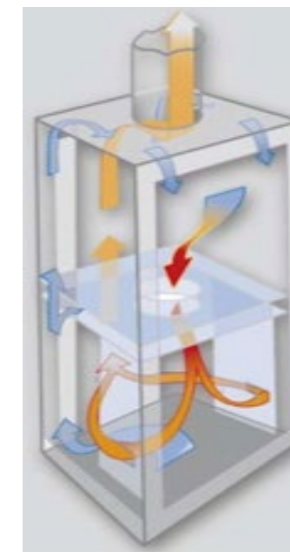

Source: [4]

Reduction of air pollution and GHG

The combination of emission reduction devices enables combusting biomass as a climate friendly fuel (and thus reduced fossil CO₂ emissions) with significantly reduced particle emission and significantly lower amounts of unburnt hydrocarbons. The typical particle emissions of optimised stoves are below 1 mg/m³ even in the case of non-optimal combustion conditions. NO_x emissions cannot be reduced with these devices, without the use of catalysers. The actual particle reduction rate depends on many parameters, including the fuel, the primary combustion system, the technical approach of the system, and the user behaviour. Generally, continuous operation where the emission levels are already very low, the precipitation efficiency can be as low as

B) Secondary measures in the exhaust gas using active or passive filter technology. Active filters are typically electric filters, which use electrostatic charging with a voltage between 15,000 and 30,000 V. The particles are precipitated at the chimney wall and can be cleaned whenever the chimney sweep performs the regular maintenance. Therefore, the lifetime of the filter is not limited through a regular exchange interval. An electricity connection is needed for these systems. Other technologies, such as flue gas scrubbers or passive ceramic filter systems often require replacement and maintenance at intervals of 1-2 years and are therefore less common. In addition to filter systems, digital equipment can optimise the operation of stoves and boilers.

Figure 7: Filters for wood and other solid fuel stoves can be placed in the chimney or integrated into the stove

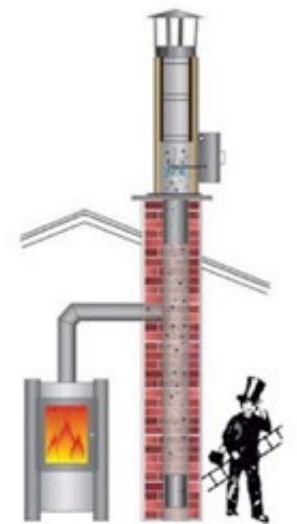

Source: [2]

10%, whereas in partial load or irregular combustion conditions, the efficiency can be significantly higher and reach values well above 60%. For stoves and small combustion devices, precipitation efficiencies efficiencies lie between 20% and 85%. Typically, the efficiencies actually achieved are significantly lower than the nameplate efficiencies. A detailed overview is given in Struschka et al. (2017) [2].

Market development

The introduction of the Federal Ordinance on Pollution Control (see below), significantly increased the demand for post-combustion exhaust gas cleaning. Up to 300.000 retrofit filter systems were sold per year. However, sales figures have declined in the past years, as many existing systems had already been retrofitted. The market for

small devices is dominated by electrostatic precipitators (“electrofilters”). In the case of biomass stoves with primary measures, there is no reliable data available as the statistics do not differentiate between the emission level of devices.

Economics and business cases in Germany

The typical investment costs for small biomass stoves without emission reductions start as low as 300 €. A market study carried out as part of the evaluation process of the Market Incentive Programme, indicates average costs of around 1.500€ per filter for stoves with primary measures and reduced particle emissions with heating capacities between 5 and 10 kW_{th} [3]. These filters can also be easily scaled to larger capacities. In the case of large boilers, however, often scrubbers and other filter technologies are used rather than electrostatic precipitators. As explained above, the filter does not have to be replaced in short intervals but instead is cleaned by the chimney sweep as part of the regular maintenance. The heat generation cost depends on the primary heating system.

The interest in pollutant reduction of biomass boilers and ovens has been spurred by three political measures:

1. The Federal Ordinance on Pollution Control (BImSchV)

demands strict emission levels of ovens and boilers. For new central systems, emission levels of 0.02 g/m³ particles and 0.4 g/m³ CO are required (related to an oxygen content of 13%). For existing systems, the BImSchV allows transitional periods. For single room fireplaces, the values differ according to the application; room heaters may emit up to 0.04 g/m³ of dust.

In fact, many stoves built between 1985 and 1994 need to be replaced or retrofitted with filters. The owner of the system must prove the fulfilment of the BImSchV via certificates of the manufacturer, an on-site measurement or a filter system certificate. According to recent estimates of the industry association HKI, around 2 million systems have already been replaced or upgraded since the enforcement of the BImSchV. This led to an approximately one-third reduction of particle emissions from biomass heating.

2. The **Market Incentive Programme (MAP)** is a funding programme of the Federal Ministry for Economic Affairs and Energy (BMWi) which provides incentives to make greater use of renewable energy to generate heat: private consumers, companies, municipalities and other eligible parties such as non-profit organisations receive a grant from the state if they replace their old heating system with an efficient solar thermal installation, biomass installation or heat pump. Funding is also provided for

Figure 8: Particle reduced stove in a private home



A typical application is this stove in a private single-family house (with a living space of 170 m²). The stove covers approximately 30% of the heat demand of the building. The rest is covered by a conventional heating system. The wood is delivered by a local biomass supplier and partly covered by private wood supplies. Essential for the twin-fire operation is dry and clean wood and an adequate ignition process of approximately 20 min.

setting up heat networks and heat storage units. The MAP supports different kinds of biomass boilers: pellet stoves (with a water connection), pellet boilers, wood chip boilers and log wood gasification boilers. It does not support very small biomass stoves due to the low investments needed for these devices.

In the case of the above-mentioned technologies, the MAP increases the support for biomass equipment by 1,500 €, if additional gas cleaning equipment is installed, and by 750 € for retrofitting existing boilers with gas cleaning equipment. There is a positive list of eligible equipment fulfilling the MAP's

3. Recently, **local municipalities** facing severe air pollution have introduced an alarm for critical levels of particulate matter. On critical days, for instance days with inversion weather and low wind speeds, the use of biomass furnaces, stoves and certain boilers is prohibited in some German cities. On those days, only systems with exhaust gas cleaning may be operated.

Figure 9: Retrofit of an existing biomass stove

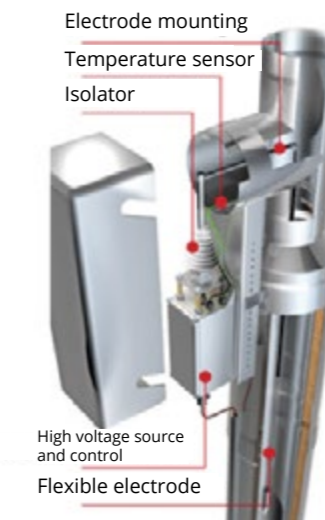

Source: Schröder Ökotube (own translation)

Due to the Federal Ordinance on Pollution Control, thousands of biomass stoves are currently being retrofitted with electrostatic precipitators. These systems filter the exhaust gas with electrostatic forces such as the Oekotube which, like the Airjekt from Kutzner&Weber, is one of the market leaders. The electricity demand in standby mode is less than 1 Watt, in filter mode around 14 Watt.

Ideas for pilot installations in China

China has abundant biomass resources and offers broad prospects for biomass energy development and utilisation. The total amount of biomass resources such as crop straw, forestry residues and energy crops that can be used for energy generation amount to 460 million tonnes of coal equivalent (tce) per year. Amongst them, forestry residues are the largest biomass source accounting for 350 million tonnes/year (equalling 200 million tce) and 43% of available biomass. Crop straw amounts to 340 million tonnes/year (170 tce) accounting for 37%. At present, China only utilises 35 million tce, equal to a utilisation rate of 7.6%. The richest biomass resources exist in North and Northeast China and Xinjiang.

In 2018, the heating area of decentralised biomass furnaces in northern China was about 25 million m². Decentralised biomass stoves require a low initial investment, are convenient and flexible in operation, and can be used for both cooking and heating purposes. Due to their low operating costs (lower than coal), they are affordable for low-income households. Hence, biomass stoves show a great application potential in rural areas. Today, biomass stoves are mainly used in North China's rural areas and in areas along the Yangtze river basin that are characterised by hot summers and cold winters. In areas where clean heating regulations prohibit or restrict the utilisation of coal, and the necessary infrastructure for gas or electricity heating has not yet been developed, biomass stoves have become the main way to replace coal boilers.

However, biomass heating currently faces challenges such as the compliance of stove emissions with local environmental protection standards. At present, there is no nationally unified emission standard for centralised boilers or household stoves. Some provinces have formulated emission standards for biomass-fired boilers. In Tianjin, for example, the emission limits for particulate matter, sulphur dioxide and nitrogen oxides of biomass boilers are 20mg/m³, 30mg/m³ and 150mg/m³, respectively. Current heating policies encourage the utilisation of central biomass boilers that meet local emission standards. Decentralised household stoves, however, are currently not explicitly encouraged due to the difficulty in controlling and monitoring emissions.

Low-emission biomass stoves, as mentioned here, provide a suitable solution for domestic space heating in China. Rural, but economically strong, areas and single-family houses could offer the right framework conditions for pilot projects. Such solutions can help to significantly reduce soot emissions and achieve NO_x emissions that meet Chinese emission standards. Pilot project participants should conduct tests concerning the applicability of different fuels and their compliance with local pollutant emission standards. Biomass stoves for such pilot projects should be adopted to Chinese customs as much as possible, including the possibility of using them as cooking stoves.

4.2 Air source heat pump system in combination with a PV module and an electric heater for domestic hot water

A heat pump utilises heat from a heat source at a low temperature level, raises the temperature level and supplies the heat sink with a high temperature level. Most heat pumps installed in Germany work with electric engines to drive the mechanical compressor (Figure 10). An air source heat pump uses outdoor air or exhausts air from inside the building. Air source heat pumps are a standard technology especially for new buildings.

Solar-PV modules and DHW thermal storages with integrated electrical heating elements are also commercially well developed and widely installed in various types of buildings. However, the integration of these three technologies as a decentralised combined heat-electricity system is an innovative heat-and-power-system. In Germany, reduced electricity tariffs are available for heat pumps when energy suppliers can

Figure 10: Principles of electric driven compression heat pump

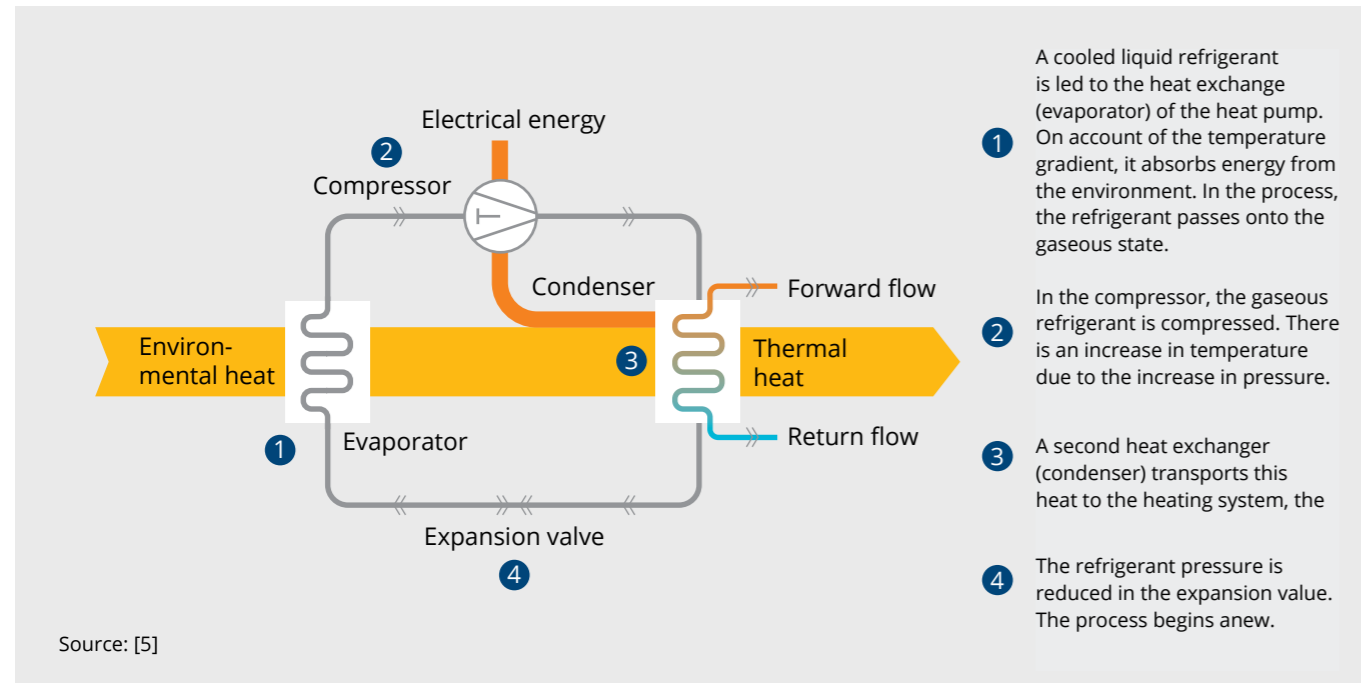

control and switch off the units for several hours during the day. Thus, the combination of heat pumps with

thermal storage and solar PV enables supplying heat at every hour even if the heat pumps are switched off.

Application	space heating, hot water and space cooling in residential and non-residential buildings via compression heat pumps.
Target group / customers	mainly owners of / investors in new or renovated single-family houses.
Advantages	<ul style="list-style-type: none"> • use of renewable energy sources for heating and electricity, • all three components are proven technologies, innovative is their integration with a smart control unit, • increased lifetime of heat pump due to lower switching time, • increased self-consumption of electricity produced decentrally, • reduction of GHG emissions.
Challenges	<ul style="list-style-type: none"> • efficient heat pump operation for space heating requires low heat distribution temperatures below 55°C -> requires high energy performance of the building, • cost effective only with small differences between electricity and fossil fuel prices.
Costs	<ul style="list-style-type: none"> • depend on the energy performance of the building in question, • investment in Germany 855 - 1630 €/kWth depending on system size. Investment costs for PV rooftop systems (incl. inverter modules) 800 - 1,500 €/kWpeak. Costs for grid connection 500 - 1,000 € [9,10]. An integrated system suitable for a typical single-family house with an air source heat pump with 15 kWth and PV rooftop installations of 10 m² requires investments of about 34,500 €, • levelised cost of heating (LCOH): 20 ct€/kWh depending on the full-load hours (standard gas condensing boiler 13 ct€/kWh).
Specific CO₂ emissions	130 g/kWh _{th} (assuming an average emission factor of 570 g/kWh _{el} for the current German electricity mix; zero or negative emissions possible if avoided emissions avoided from PV electricity used for running of the heat pump system and household appliances are taken into account)





Technology description

Types of air source heat pumps

Air source heat pumps can be differentiated according to the heat source and the heat distribution medium. Exhaust air heat pumps are smaller units that are mainly installed as heat recovery systems with automatic ventilation systems and other heating systems. Air source pumps as primary heating systems use outside air. Depending on the specific requirements of the individual

buildings, air source heat pumps can be installed inside or outside of the building or as split-units with the ventilator unit outside. Both water-based systems (see description in section 4.3) and air-based systems are suitable for heat distribution. The integration with a PV system and a hot water tank is similar for all system types.

Table 4: Different system components of air source heat pumps

	Exhaust air heat pump	Air source for heat pump
Heat source	Exhaust air	Ambient heat
Heat collector	Heat exchanger	Ventilator
Unit type		Monoblock inside
	Monoblock inside	Monoblock outside Split-unit
Heat / cooling distribution system	Fan coil unit	
	Radiators => flow temperature 55°C	
	Panel heating / floor heating => flow temperature 55°C	
	Thermo-active building elements	

Capacity and yield

The capacity of a typical air source heat pump for space heating and hot water in residential buildings ranges from 10 to 20 kW_{th}. Thermal capacities of DHW-only heat pumps start at 2.5 kW_{th}. Within a cascade circuit of several heat pumps, the capacity can be increased to over 100 kW_{th}. The typical flow temperatures of an air source heat pump can reach up to 60°C. Since heat pumps operate more efficient at lower temperatures, an economically and ecologically reasonable operation requires temperatures lower than 40°C.

The efficiency of heat pumps is expressed by the Coefficient of Performance (COP), which describes the proportion of thermal energy output and electricity energy input (Figure 11) shows the COP for supply temperatures of 35°C and 50°C as a function of the ambient temperature. The influence of ambient temperatures on the efficiency

is more relevant than for ground source heat pumps. However, the flow temperatures of the heat distribution systems have an even higher impact on the COP. In order to cover a high difference between ambient and temperatures on days colder than - 5°C, ambient heat pumps are usually operated as either bivalent systems with another heating system, or as mono-electric systems with thermal storage and an electric heating element. If ambient temperatures are too low and the heat pump cannot supply the required temperature anymore, the electric heater switches on as soon as the threshold at which a heat pump becomes inefficient is reached. The electricity used for the electric heating element during the year is considered in the calculation of the annual heat coef-ficient of performance. Air source heat pumps can achieve COPs of 3.5 to 4.3.

Figure 11: COP as a function of ambient temperature for different supply temperatures

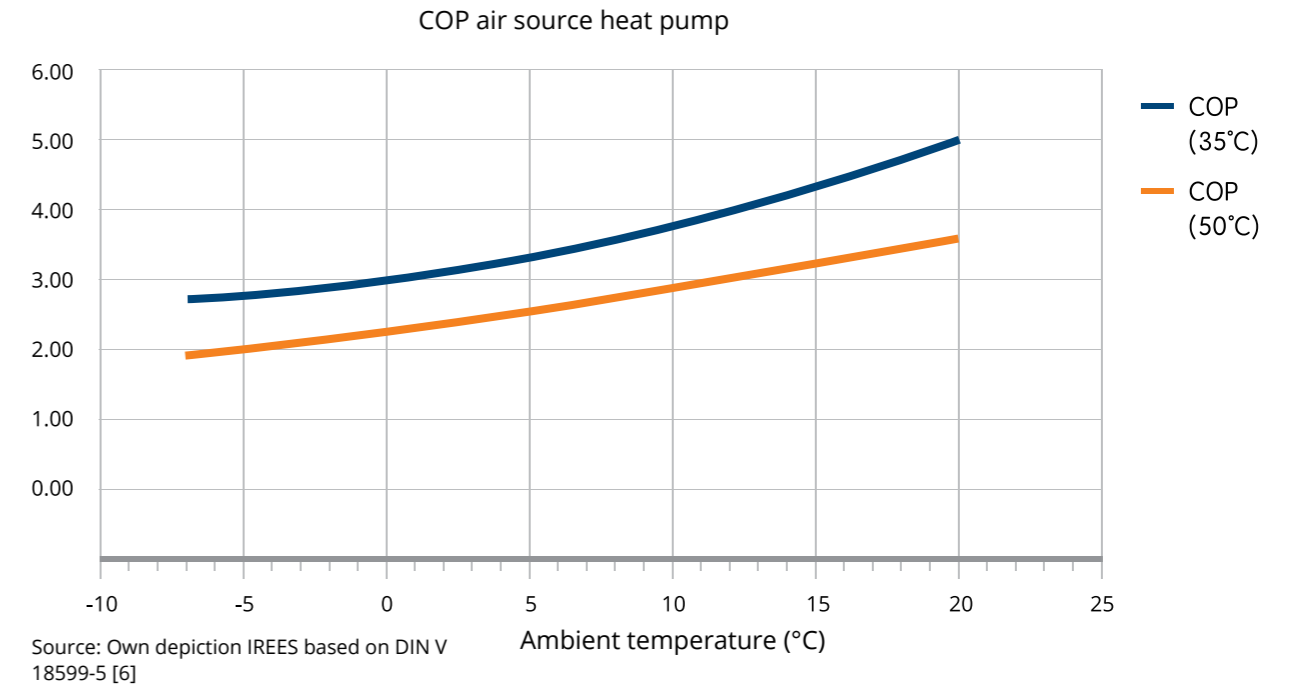

Air source heat pump with PV and DHW storage and electrical heating elements

The combined system approach increases the self-consumption share of the PV system and reduces CO2 emissions for the heat supply by using RES for the electric drive of the heat pump. Furthermore, the direct connection between the PV installation and the heating element of the hot water tank enables heat pump shutdowns during the off-season. Due to this variable electricity tariffs, individual load profiles and weather forecasts can be considered for the optimal operation of the individual system components. Depending on the tariff regime, the system could operate according to the following priorities (most important listed first):

1. Electricity from PV is used for household appliances.
2. Electricity from PV is used for heat pump operation during the heating period
3. The PV-heating element is activated outside the heating season for hot water generation
4. The PV-heating element is activated during heating season for the generation of space heating generation if temperatures are too low for the heat pump
5. The electricity from the grid is used for powering the heat pump as well as household appliances in cases where the PV generation not sufficient
6. PV-electricity is fed in to the grid (surplus energy).

The system can also be extended with a battery storage. The communication of heat pumps with PV- systems is

done via a standardised SG- (smart grid) ready interface [8]. Using this interface, the heat pump can be plugged directly into the PV inverter. Thereby, certain thresholds for the minimum electricity production can be defined before electricity is used for the heat pump. This would enable to achieve only the achievements of step 1 and 2 of the above presented control strategy. In order to realise an integrated approach, different loads need to be known, requiring the installation of smart meters and an energy management systems (EMS). Modern PV inverters already have (EMS) software included, which considers not only the loads of different household appliances and heat pumps, but also real-time weather data from the Internet.

Applications

Air source heat pumps are mainly installed in new residential and small non-residential buildings. They are usually applied for space heating and domestic hot water preparation. Heat pumps are best suited for new buildings or well insulated existing buildings with floor heating. As heat pumps operate more efficiently at lower temperatures, typically, buildings with a usable surface of less than 250 m2 can be heated. Air source heat pumps also offer the possibility of cooling.

The combination of PV and an electric heating element for domestic hot water production suits single-family houses with a favourable ratio of roof area to living space, compared to multi-family buildings. In non-residential buildings, a combination of PV and air source heat pumps

is also suitable. Due to a general low hot water demand profiles in non-residential buildings, a combination with DHW electric heaters is not recommended. A system with battery storage would be more suitable for those buildings.

Reduction of air pollution and GHG

Air source heat pumps do not produce direct emissions. The reduction of GHG emissions depends on the share of self-produced electricity from PV and the GHG emissions of the electricity from the grid. A system with a smart energy management system can also consider real-time grid emission factors in the decentralised operation scheduling.

History and market development

The installation of air source heat pumps has been pushed by support schemes and regulative instruments in Germany since 2000 (see section 4.2). In 2018, 84,000 heat pumps were installed for heating purposes, 72% of which were air heat pumps. [2]. Air source heat

pumps have a market share of 33% of all heating systems installed in new buildings [7]. Since the introduction of the EEG, rooftop PV installations with guaranteed feed-in tariffs have also been widely applied, primarily in single-family houses. Considering the cost reductions of the technology over the past 15 years and the increase in electricity tariffs, self-consumption is economically more efficient than feed-in of roof-top PV. The integration of heat pumps and solar PV with storage systems and smart control systems is still a niche market. With decreasing feed-in tariffs and increasing fossil fuel prices, PV-heat applications are expected to gain a significant market share in the upcoming 5-10 years.

Economics and business cases in Germany

Investment and OM costs

The average specific investment costs for air source pump systems, including thermal storage for hot water and space heating as well as the installation of air source heat pumps, are between 855 €/kW_{th} and 1,630 €/kW_{th} depending on the size of the system (Figure 12).

Figure 12: Specific investment costs of air source heat pumps in Germany

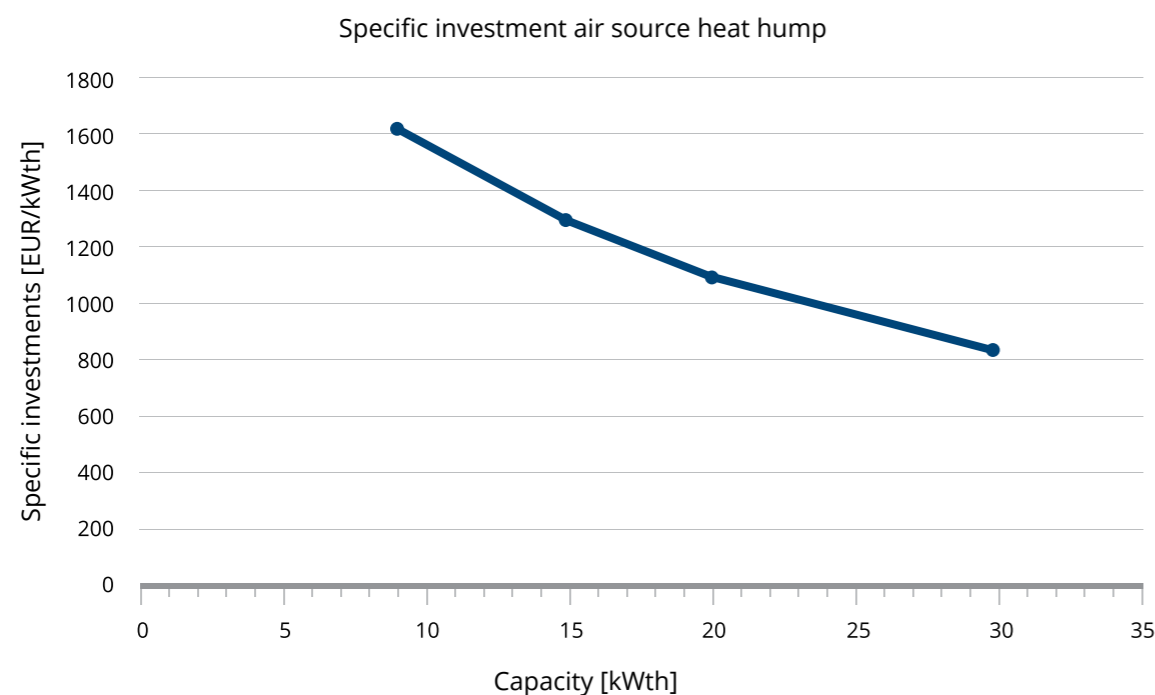

Source: Own depiction IREES based on [8]

Investment costs for PV roof-top systems, including inverter modules, are between 800 and 1500 €/kW_{peak} and 330 €/kW for the inverter and assembly system. The costs for the grid connection are between 500 –

1000€ [9,10]. An integrated system suitable for a typical single-family house with an air source heat pump with 15 kW_{th} and PV roof-top installations of 10 m² requires investments of around 34,500 €.

Table 5: Specific investments of air source heat pump with PV and a DHW electric heater

Component	Specific investments
Air source heat pump, thermal storage, control system [15 kW]	1,631 [€/kW]
PV system [10 m ²]	1,400 [€/m ²]
Grid connection PV	500 [€]
PV electric heating element [3 kW]	750 [€]

Levelised costs of heating

The costs for annual operation and maintenance amount to approximately 1% of the investment costs. The energy costs depend on the share of available PV electricity available for the heat pump operation as well as the availability of special heat pump tariffs.

For a typical new single family house (SFH), the levelised costs of heating for the integrated systems are about 20 ct€/kWh, without investment grants. The levelised costs of heating for a standard gas condensing boiler are about 13 ct€/kWh.

Figure 13: Volunteer fire station in Lachendorf



The fire station was built in 2014. Two air source heat pumps were installed for space heating and for domestic hot water. The heat is distributed through panel heating in the rooms. The rooms are supplied with three different temperature levels, which depend on the use schedule and the activities to be performed. There are PV modules on the roof to supply the accumulator, which is used to secure the electricity supply during blackouts. Source: [1]

Figure 14: Multi-family house in Rösrath



This multi-family house was built in 2011. There are seven flats with a total area of 541 m² occupied by 11 people. The air source heat pump delivers space heating through panel heating. Floor heating is used to distribute the heat in the building. The capacity of the heat pump is 22.4 kW and the annual COP is around 4.03. The heat pump was combined with PV modules, which leads to the best energy efficiency values in this case. Source [2]

Figure 15: Roth logistics centre

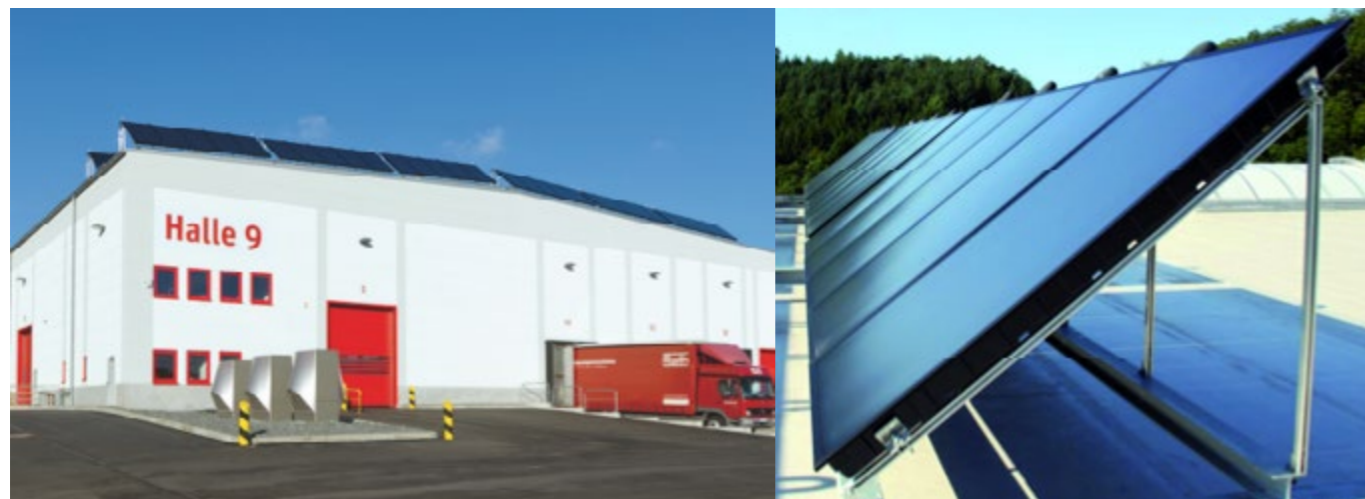

The heat supply is based on a combination of air/water heat pumps, a thermal solar system of 60 m² flat-plate collectors, a brine/water heat pump and an underground sprinkler basin with a useful volume of 700 m³, where solar energy can be stored up to 38°C. The solar thermal energy is used as a heat source for the brine/water heat pump during the heating period. The required amount of electricity of the entire heating system is mainly generated by a PV system with 86.5 kW_{peak}. The energy generated from the environment for heating the halls corresponds to a requirement of around 51,000 litres of heating oil. With the electricity generated and the environmentally friendly alternative to fossil fuels for heat generation, Roth saves 159,000 kilograms of CO₂ annually. Source: [3]

Policy support for air source heat pumps

To enhance the reduction of GHG in the building sector, there are several support programs and regulative instruments to increase the share of renewable heating. The main national support programme for heat pumps is the Market Incentive programme (MAP) [7]. The programme does not only provide investment grants, but also sets market standards regarding quality and efficiency of the technologies and increases the diffusion of innovative systems. For heat pumps, there are two funding components in the programme:

- MAP basic funding: the installation of an efficient heat pump in an existing building (annual COP ≥ 3.5 for air source). The grants for a ground source heat pump are around 1,300 € to 1,500 €.
- MAP innovation funding: the installation of a highly efficient heat pump (annual COP ≥ 4.5) in existing or new buildings. Requirement: Panel heating and quality check after one year. In existing buildings, the grants are around 1,950 € to 2,250 €. In new buildings, they are around 1,300 € to 1,500 €.

In addition to this funding there are bonus grants for additional benefits such as:

- Combination bonus: these are bonuses for benefits such as: a solar or biomass system or a heat network

connection. The bonus grant is about 500 €.

- Efficiency bonus (applicable to existing buildings only): a bonus for meeting the requirements for the building envelope of a “KfW Efficiency House 55” (i.e. the building consumes only 55% of primary energy compared to the building code). The bonus grant is + 50% of basic or innovation funding.
- Workload management bonus: there is storage for with at least 30 l/kW and an interface according to SG-Ready guidelines. The bonus grant is about 500€.
- APEE bonus: for the (Anreizprogramm Energieeffizienz): replacement of inefficient fossil boilers, night storage heating or electric heating in connection with optimisation measures. The bonus grant is + 20% of total funding.
- APEE bonus: for optimisation measures such as heating checks, hydraulic balancing or efficiency increasing measures. This bonus is about 600 €.

Another subsidy programme is run by the KfW Development Bank (Germany’s state-owned development bank). The two main programmes are energy efficient renovation and energy efficient construction. The programme supports major renovations of existing buildings as well as new buildings that achieve an energy

performance standard above the requirements of the building codes. The standard is defined by the energy performance of the building envelope and the maximum primary energy consumption compared to a reference building according to the building standard. For instance, a KfW efficiency house 55 consumes only 55% of

primary energy compared to the building code standard. A combination of energy efficiency measures and the installation of a renewable heating systems such as a heat pump makes achieving this standard possible.

Ideas for pilot installations in China

The utilisation of air source heat pumps combined with PV modules and electric heaters is less constrained by local conditions compared to other solutions (such as geothermal heat pumps) and adaptable to a wide range of areas. This combined solution is especially suitable for areas with high solar irradiation and minimum outdoor temperatures of -5°C in winter. In China, such a solution could be applicable to areas not covered by central heating networks, e.g. in rural areas, and that can economically afford such solutions. However, air source heat pumps should not be employed in areas with outdoor temperatures reaching below -15°C due to the associated efficiency losses. This solution could be used as a supplementary heat source for urban district heating or as a main heat source in rural areas. Currently, air source heat pumps are being used in Henan, Hebei, and Beijing. Pilot projects could be installed in rural areas and in larger cities, focussing on:

- Decentralised heat supply in single family houses and residential buildings, commercial buildings or public buildings,
- Combined heating/cooling applications,
- Heat pumps utilising exhaust air from air pumps or other sources,
- Combinations with existing distributed PV installations.

In the future, efforts should be made to improve the heating capacity, energy efficiency and operational reliability of air source heat pumps in low temperature environments.

China’s government actively supports the utilisation of PV. The government has set up subsidy policies for the utilisation of PV in demonstration projects both for the alleviation of poverty and subsidy policies for distributed PV (the principle being: self-consumption plus excess electricity to feed into the grid), amongst others. In recent years, many applications for combining distributed PV with air source heat pumps have been applied in residential buildings, factories and school campuses. Factors for this positive development are 1) provision of both heating/cooling and green power, 2) distributed solutions save on power grid expansion and transformation, 3) (financial) support via both clean heating policies and PV support programmes. At present, Hebei Province and other areas have developed rural clean heating programmes that promote “photovoltaic plus” heating solutions. This has been piloted successfully in some rural villages.

4.3 Ground source heat pump (GSHP)

A ground source heat pump (GSHP) uses the energy stored in the soil or in the ground water as the heat source. The applicability of GSHP as a climate protection technology depends on the ratio of the compressor’s electricity consumption and the resulting usable

thermal energy as well as the energy sources used to generate electricity in power plants. The following table summarises the main applications, advantages and challenges of the technology, which will be described in detail in this chapter.

Application	Use of geothermal heat for space heating, hot water and space cooling in residential and non-residential buildings by compression heat pumps.
Target group / customers	Mainly owners / investors of new or renovated single-family houses. The targets for combined heating and cooling applications are in particular new, highly efficient office buildings.
Advantages	<ul style="list-style-type: none"> • Usage of thermal energy in soil, • Proven technology, • Higher performance than air source heat pumps, • Possibility of natural cooling (without an active air-conditioning system) during cooling period, • Reduction of GHG emissions
Challenges	<ul style="list-style-type: none"> • Efficient operation requires low heat distribution temperatures in buildings of below 55°C, • Space requirements for geothermal collectors/probes, • High investments required for ground-coupling methods, • Cost effective in countries with small price differences between electricity and fossil fuel prices.
Costs	<ul style="list-style-type: none"> • depending on the energy efficiency of the building stock, • specific investment costs (including installation costs) range from 1,350 to 2,200€/kW for GSHP (capacity range 8 - 30 kW), • Levelised Cost of Heating LCOH: 19 ct€/kWh depending on the full-load hours.
Specific CO₂ emissions	126 g/kWh _{th} (useful heating energy)



Technology description

Types of ground source heat pumps

The possible renewable heat sources are air, soil

(geothermal), water, waste water and exhaust air. In the industrial context, different heat sources occur such as waste heat or exhaust air from any heat generating process. Geothermal heat pumps deploy either ground water or soil as the heat source.

Table 6: Different system components of ground source heat pumps

	Water-Water heat pump	Brine-Water heat pump
Heat source	soil	ground water
Heat collector	vertical probes bore depth: 1.5 m	vertical probes bore depth: 40 – 100 m horizontal collectors depth: ~1,5 m area: 2 m ² / m ² living area
Heat / cold distribution system	radiators => flow temperature 55°C panel heating / floor heating => flow temperature 35°C thermo-active building elements	  

This way, the heat stored in the ground is tapped and the natural temperature below ground is used. Depending on the climatic and geological conditions in Central Europe, this is about 10°C. Hence, even in winter, the temperature difference between the heat source and the supply temperature of the heating system is small. This enables an efficient operation of the heat pump year-round. Two different heat source systems are available for this purpose: vertical geothermal probes or horizontal geothermal collectors. Both systems belong to the so-called closed systems. Water-based heating or cooling distribution systems are required to supply the rooms inside buildings. Since electricity demand for the compressor increases with the temperature difference between the heat source and the heat sink, low-temperature distribution systems such as underfloor heating or thermo-active components (e.g. cooling ceilings) are best suited for heat pumps.

Capacity and yield

The capacity of a typical ground source heat pump for space heating and hot water in residential buildings ranges from 6 to 34 kWth. In a serial setting of several heat pumps, the capacity can be increased to above 100 kWth [9][10]. A single stage heat pump can supply heat up to 70°C. Since heat pumps operate more efficiently at lower temperatures, an economically and ecologically reasonable operation requires temperatures of around 40°C. Figure 17 shows the COP for supply temperatures of 35°C and 50°C as a function of the ambient temperature. The figure reveals that the influence of the ambient temperature on the performance of geothermal heat pumps is far smaller than the design temperature of the heat distribution system.

Figure 16: COP as a function of ambient temperature for different supply temperatures for GSHP

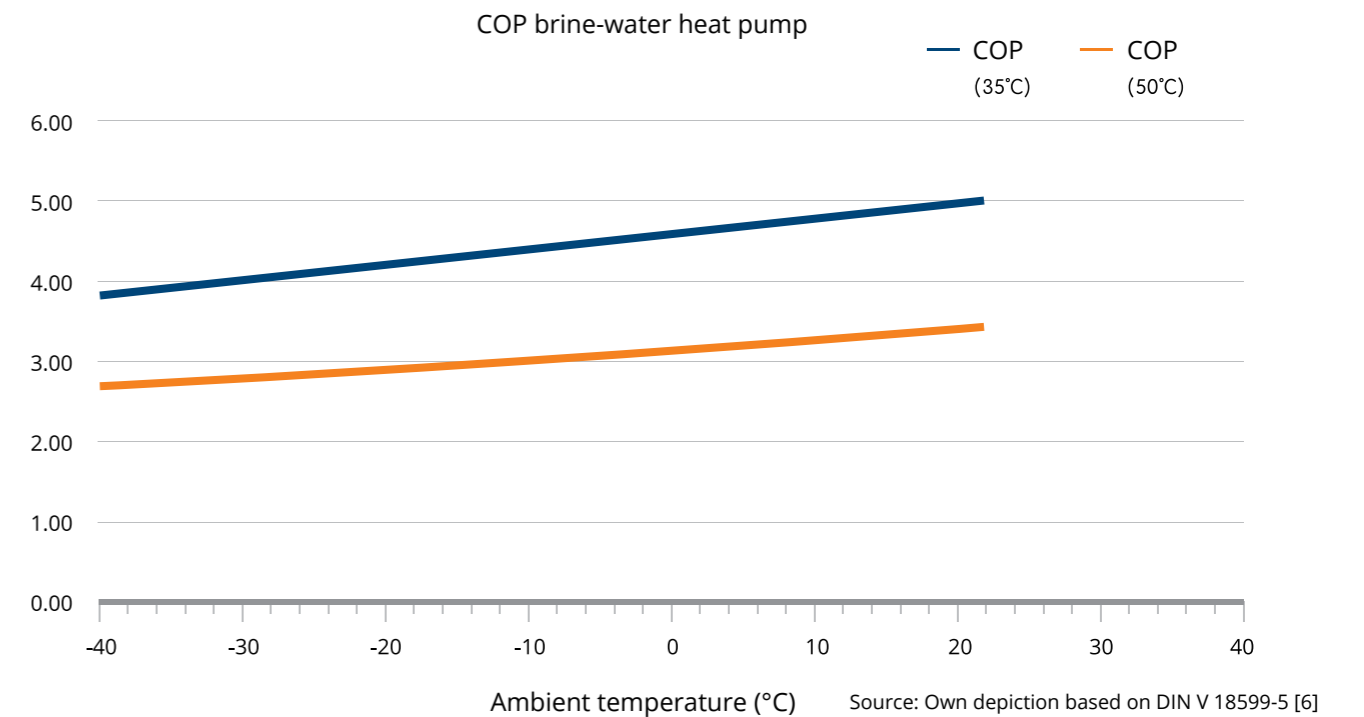

However, the COP represents only a performance indicator for certain parameters at a given point in time. Therefore, the evaluation of heat pump efficiency requires the consideration of electricity input and supplied heat / cold throughout the year. Very efficient geothermal heat pump systems achieve an annual coefficient of performance of 4.5 and higher.

Applications

Geothermal heat pumps are mainly installed in new

and renovated buildings. They are usually applied for space heating and domestic hot water preparation. Like air source heat pumps, GSHP are best suited to efficient buildings that enable them to operate with a low heat distribution temperature below 55°C. The influence of outdoor temperatures on the energy performance of GSHP is much smaller than it is for air source heat pumps. Reversible heat pumps also offer the possibility for cooling, serving as a natural cooling device during

the summer season. In Germany, such applications can be found mainly in non-residential buildings. In other European countries with a higher cooling demand such as Italy and Spain, reversible heat pumps are more common, particularly to provide air-conditioning. Large heat pumps for industrial applications and district heating are becoming increasingly important. However, they are still niche applications.

Important combinations with other technologies

Heat pumps can be combined with various other technologies. In order to reduce the GHG emissions stemming from the electricity supply, heat pumps can be combined with roof-top photovoltaic modules. With them the self-consumption share of the PV installation increases and the electricity consumption from the grid is reduced. In case of low feed-in tariffs for PV and high electricity prices, a combined PV-heat pump system can be very cost-effective. In addition, a battery storage might be a reasonable supplement, especially if flexible electricity tariffs exist. A combination with solar thermal collectors in order to reduce the required supply temperature is also possible.

Important system components to increase the efficiency and enable a flexible operation are hot water and buffer tanks. With those heat pumps can operate during hours with low electricity prices in times with a high share of RE feed-in in the electricity grid. Since the investment costs for thermal storage are currently significantly lower than for battery storage, the conversion of electrical energy into thermal energy is economically more efficient than storing electricity. Depending on the size of the installed hot storages installed, the heat demand can be covered for periods ranging from 6 hours to a couple of days. These storages enable a flexible operation of heat pumps from the perspective of the electricity sector with increasingly fluctuating RES-E production. On the other hand, a combination with ice storages as seasonal storage will significantly increase COP and reduce the overall load in the electricity grid during winter. The heat pump technology generally fits the concept of sector coupling perfectly. It uses less electricity than other technologies, supplies heat over the year and can operate on a large scale.

Nevertheless, an efficient operation of heat pumps requires a high energy efficiency standard of buildings. Therefore, insulation of roofs, outer walls and efficient windows are required in order to decrease the supply temperature.

Reduction of air pollution and GHG

GSHP do not produce direct emissions. Nevertheless, due to the electricity demand, the contribution to GHG

reduction depends on the CO₂ emissions of the electricity generation in the respective country, which at present is high in China with a high share of coal in the power mix. In combination with RES energy generation, there are no further emissions. In any case, the emissions of heat pumps are lower than from direct electric heating.

History and market development

The first pilot application of GSHP was documented in the USA in 1948 [11]. In Germany and other European countries, GSHP were first commercially available after the second oil crises resulting in a first significant market uptake of heat pump installations in the 1980s. Most of those GSHP were installed as bivalent systems in addition to the existing boiler. The complexity of system integration and the lack of experiences and knowledge the installers had, resulted in performance problems. Consequently, the acceptance and trust in the technology on the part of the building owners was ruined. In Germany, annual sales dropped from 25,000 in the peak year 1980 to below 1,000 by 1990 [11]. Similar developments occurred in France, Austria and Switzerland. Large boiler manufactures that had entered the heat pump market closed their respective business units and smaller companies went bankrupt. Only a few experienced companies remained in business and formed the core for the second consistent market uptake from the year 2000 onwards with the introduction of the Market Incentive Programme for renewable heating technologies. The programme provides investment subsidies for heat pumps, biomass boilers and solar thermal installations until today. Since 2009, heat pump installations have been further pushed via regulative policies such as building code requirements and the obligation to use renewable heating in new buildings.

In 2018, 84,000 heat pumps for heating purposes were sold in Germany – 28% of the heat pumps sold are ground source heat pumps and the remaining 72% are air source heat pumps [4]. Counting those, the overall market share of GSHP of heating systems installed annually is 3%. In new buildings, geothermal heat pumps have a market share of 7.6%, whereas air source heat pumps are installed in over 33% of new buildings [7].

Economics and business cases in Germany

The examples presented below in the text boxes show the application of geothermal heat pumps in combination with other technologies. The selected examples highlight the various possibilities of technology combinations with heat pumps. The majority of GSHP in Germany are individual heat pumps in single family houses.

Investments, operation and maintenance (OM) costs, energy costs

In Germany, specific investment costs, including

installation costs, range from 1350 € to 2200 €/kW for GSHP in the capacity range of 8 to 30 kW. This means that the investment costs are 3–4 times higher compared to a conventional gas boiler. The effort for heat source deployment for ground source pumps is much higher than for air source heat pumps. It requires the burying of horizontal geothermal collectors or the drilling of boreholes for geothermal probes, which involves test drillings, temperature evaluations etc.

Operation and maintenance costs are around 0.5% of the investment costs. Operating costs vary depending on the heat source used. Energy costs and with them the cost-effectiveness depend highly on the overall energy performance of the building, since low supply temperatures are required (see above). Especially for old buildings without insulation and old radiators, heat pumps are not so well suited.

Figure 17: Specific investments of GSHP in Germany

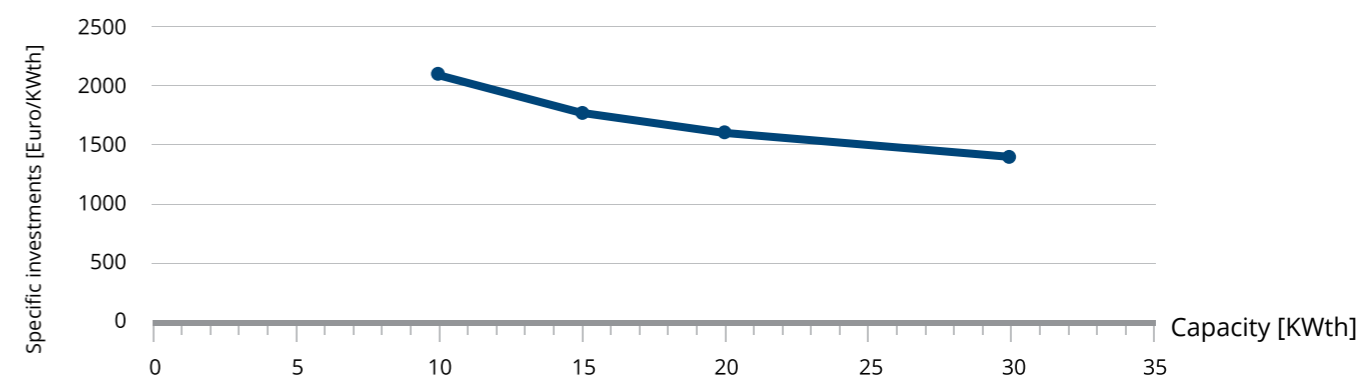

Source: Own depiction IREES based on [8]

Figure 18: Old pumping station Haan – heat pump with ice storage in a reutilised non-residential building



Four planning offices jointly completed a complex building modernization. The old pumping station was partially gutted and 1000 m² of new office space was integrated, which today serves as headquarters of the companies. The offices are heated or cooled by a geothermal heat pump with ice storage. In addition, heat recovery from supply and exhaust air ensures energy efficiency. The ice reservoir has a diameter of eight metres and a height of 2.20 metres. This results in an ice volume of 110 m³. A solar absorber fence on the property absorbs solar energy in the form of heat and stores it in the water of the ice reservoir at a low temperature level. If heat is needed to heat the office section, the ice storage tank transfers it to the heat pump. The heat pump uses geothermal and solarthermal heat for heat generation. It holds a capacity range of 42.8 kW and an annual COP of 4.3. Source: [5]

Levelised cost of heating

For a typical SFH with 150 m² of living area and a heating demand of 100 kWh/m² heating demand, levelised costs of heating (LCOH) are with 19 ct€/kWh. In order to evaluate the economic efficiency, LCOH needs to be compared with a standard condensing boiler as an alternative reference technology, yields a LCOH of 13 ct€/kWh.

Policy support for GSHP

In the building sector, there exist several support programmes and regulatory instruments to increase the share of renewable heating and to reduce GHGs emissions. The main national support programme for heat pumps is the *Market Incentive Programme* [7]. The programme does not only provide investment grants,

but also sets market standards regarding quality and efficiency of the technologies and increases the diffusion of innovative systems. For heat pumps, there are two funding components in the programme:

- MAP basic funding: installation of an efficient heat pump in an existing building. (annual COP ≥ 3.8 for ground coupled) The grants for a ground source heat pump are around 4,000 € to 4,500 €.

- MAP innovation funding: installation of a highly efficient heat pump (annual COP ≥ 4.5) in existing or new buildings. Requirement: panel heating and quality check after one year. In existing buildings, grants are around 6,000 € to 6,750 €. In new buildings they are around 4,000 € to 4,500 €.

In addition to this funding there are bonus grants for additional benefits as reported in chapter 4.2.

Figure 19: Headquarters of Freiberg Instruments Ltd. – space heating and space cooling for an office building



This headquarters building for Freiberg Instruments Ltd. is heated with a ground source heat pump combined with PV modules. The heat is collected by four geothermal probes at a depth of 120 – 130 metres. The use of geothermal energy enables not only the heating of the building in winter, but also cooling in summer. The heat pump then uses the relatively cool temperature below ground and at the same time regenerates the heat source by feeding excess heat into the ground. The heat pump system was designed for a heating load of 45 kW and a cooling load of 50 kW. An above-average efficiency of the heat pump with an annual COP of 4.8 could be proven. Source: [6]

Figure 20: East wing of Geneva airport – large geothermal heat pumps for airport terminal



The east wing of the Geneva airport has been renovated in recent years and will reopen in 2020. The energy supply is based on a ground source heat pump with over a hundred geothermal probes, 5000m² of PV modules, a rainwater collection device and the use of natural light. The use of geothermal energy to meet the demand for heating and cooling is a central aspect of the concept. There are two heat pumps with a capacity range of 600 kW. The heating throughout the whole building is achieved by panel heating. Source: [7]

Ideas for pilot installations in China

Pilot projects could be initiated in two areas. Centralised and distributed GSHP pilot projects are applicable primarily in newly developed building areas in the vicinity of larger cities. Distributed GSHP pilot projects might be combined with a cold district heating grid. As not only the heating but also the cooling demand is relevant in China, combined heating and cooling with reversible heat pumps would be a cost-effective option, especially for new residential and non-residential areas. In contrast to Germany, where GSHPs are mainly installed in single-family houses, pilot projects in large multi-family houses in newly developed residential areas would be an interesting case. Another idea for pilot projects would be combining GSHP with building energy efficiency measures for small residential buildings in rural areas and commercial buildings in industrial parks. Currently, some villages in Hebei use distributed GSHP solutions for heating.

GSHPs can be used for distributed heating and cooling applications in residential and public buildings, both as distributed stand-alone solutions and in addition to central heating. At present, GSHPs are widely used for central heating and cooling of public buildings in China. Distributed GSHPs are mainly used in private houses and single-family houses with demonstration applications being carried out in Hebei and Henan. GSHPs are suitable for heating and cooling in public buildings with favourable geo-logical conditions.

When using a geothermal heat pump, it is necessary to consider the balance of the annual cooling and heating load (or demand) of the building. If the heat absorption and dissipation in the underground soil by the heat pump ground pipe (or probes) is not constant throughout the year, the thermal equilibrium in the is destabilised and affects the efficiency of the GSHP in the long term. Only using heat pumps for either heating or cooling cannot guarantee a long-term performance. In addition, the initial investment and construction costs for GSHPs are relatively high compared to other heat pump types of the same size, such as surface water sources or air heat pumps.

GSHPs in combination with heat/cold storages can be attractive solutions for regions with time-dependent electricity tariffs. GSHPs with storages can take full advantage of low prices during off-peak pricing and store generated heat for later utilisation. The greater the price difference between peak and off-peak prices, the greater the benefit for users. Such applications have been piloted in Beijing, Tianjin and Shandong in recent years. For example, Jinan Power Company (Shandong) uses a GSHP and water storage system to meet the hot and cold demand of a 22,000 m² factory building. The application of energy storage systems therefore depends above all on the peak-valley price differences compared to the investment costs.

4.4 Hybrid photovoltaic-thermal collector in combination with heat pumps

Photovoltaic modules convert up to 22% of the solar irradiance to electricity. Even with a further increase of cell efficiency, most of the solar spectrum cannot be used and is released into the environment as excessive heat. A hybrid photovoltaic-thermal (PVT) collector utilises the excess heat occurring in the PV cells by transferring it to a thermal transfer fluid, which is used for hot water and space heating (Figure 22). Therefore, PVT collectors are cogeneration systems that achieve a higher system

efficiency and better area utilisation compared to the uncoupled operation of a PV module and solar thermal collector.

PVT collectors can be integrated into every decentralised heating system. However, a combination with a heat pump and a thermal storage system is an optimal system design, which increases efficiency in the operation of each component, especially if it is applied as a quadruple

Figure 21: Useful energy for heating and electricity from solar irradiance and schematic depiction of PVT collector and heat pump

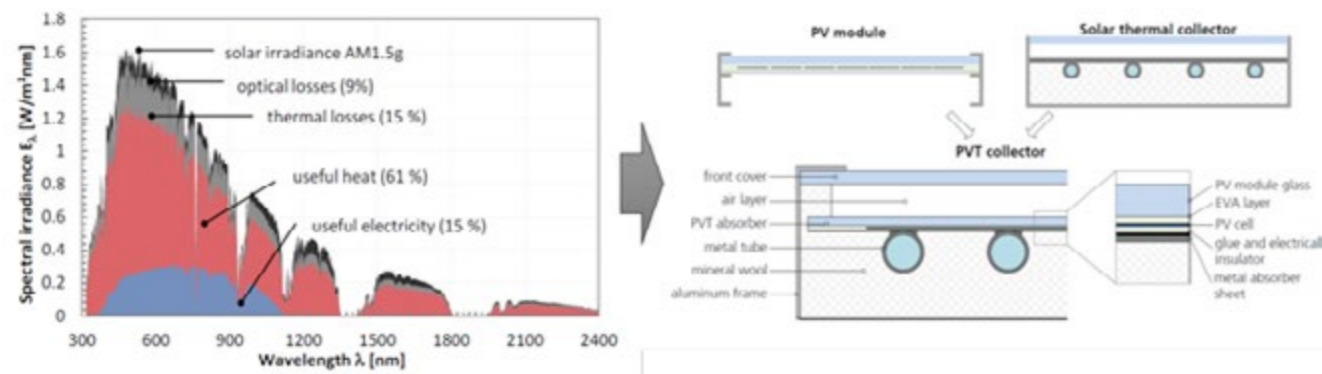

Source: [12] batch production

use system providing space heating, hot water, space cooling and electricity for appliances. The transfer of excess heat to the thermal storage simultaneously cools PV modules, which increases the efficiency of PV electricity generation. The solar absorber can be designed as a heat collector for the heat pump instead of

a ground source heat collector or ambient air collector. With them, air source heat pumps can operate with a higher efficiency and ventilators of conventional split installations become obsolete.

For the description of different types of air or ground source heat pumps, refer to sections 4.2 and 4.3.

Application	cogeneration of heat and electricity for space heating, hot water and space cooling from solar and ambient energy.
Target group / customers	mainly owners / investors of single family houses, office and retail buildings, public buildings.
Advantages	<ul style="list-style-type: none"> usage of ambient heat and solar energy for heat and electricity, optimal utilisation of roof area for electricity and heat production as well as heat collector for the heat pump, cooling of PV modules increases electricity production by 7 – 10% and extends the lifetime of the PV cells, increased efficiency and reduced space requirements compared to conventional heat pump systems, no noise pollution compared to an air source heat pump with ventilators, increased self-consumption of electricity produced decentrally, reduction of GHG emissions.
Challenges	<ul style="list-style-type: none"> efficient operation of heat pumps for space heating requires low heat distribution temperatures in buildings of below 55°C, cost effective in countries with small price differences between electricity and fossil fuel prices, The robustness has been proven for climate conditions in Germany. For regions with significantly lower temperatures during the heating season, however, the icing of collectors could impact functionality and requires further testing.
Costs	<ul style="list-style-type: none"> depends on the energy performance of the building's specific building stock, investment costs similar to that of an air source heat pump with PV, if PVT collector is produced in batch production of > 20,000 m² / year [13], <p>The technology is still in the early stages of market diffusion, large scale production and distribution, as an integrated system is likely to reduce cost.</p>
Specific CO₂ emissions	108 g/kWh _{th} (useful heating energy)/ zero or negative emissions if PV electricity for feed-in and household appliances is taken into account as avoided emissions ⁴ .

⁴ Assuming an average emission factor of 570 g/kWh_{el} for the current German electricity mix

Technology description

Types of PVT collectors

Referring to the terminology of combined heat and power plants, PVT collectors are solar cogeneration units with coupled electricity and thermal energy generation. Solar thermal collectors typically operate in a temperature range between 30°C and 90°C, whereas PV cells operate between 10°C and 60°C. Thus, there is an overlap of the operating temperature range for combined operations. However, the peak efficiency of PV modules and the optimal conversion factor of the solar thermal installations occur in different ranges, which requires a prioritisation of either electricity or heat generation in the system design [12].

PVT collectors can be classified according to the type of heat transfer fluid used, the PV cell technology, the collector design as well as the temperature stability.

See Figure 22. The heat transfer is either realised via liquids or air. Most PVT collectors such as conventional solar thermal flat plate collectors use a water-glycol-mixture as the heat transfer fluid. The integrated system design of a PVT collector with a heat pump uses a solar air absorber. The surface of the solar absorber on the backside is ten times as large as the PV module on the front [14]. Regarding the module and collector, every cell technology can be deployed for the PV module as well as different collector designs for the thermal collector. The last category distinguishes the thermal insulation of PVT collectors, whereby a low temperature concept implies lower insulation preventing the occurrence of critical temperatures for the PV cells. Temperature protection means lower thermal losses due to better insulation. Thus, higher overall efficiencies are achieved, and PV modules are protected against critical temperatures with overheating protection.

Figure 22: Classification of PVT collectors

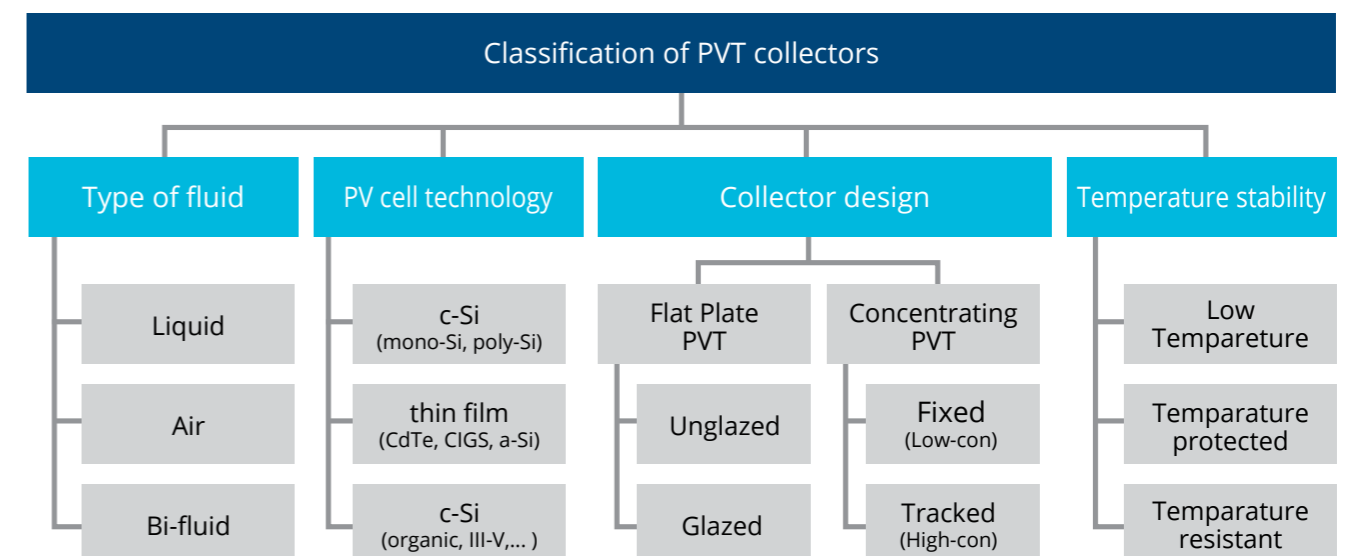

Source: [12]

Capacity and yield

The application of integrated PVT-heat pump systems can be scaled for single-family houses as well as multi-family houses and non-residential buildings such as offices or retail buildings. If the PVT collector only serves as a heat collector for the heat pump, the maximum capacity is determined by the available roof area. The heat pump requires 3 m²/kW of module area. Peak performance can be supported by an electric heating pod integrated directly into the thermal storage, a standard feature for individual heat pumps. This reduces the required capacity of the heat pump. Additionally, the

system can be operated with additional ground source heat collectors if necessary.

The efficiency of heat pumps is expressed by the Coefficient of Performance (COP), describing the proportion of thermal energy output and electricity energy input (see chapter on GSHP and air source heat pumps). With a PVT collector with optimised operation with heat pumps, an annual COP of 4.23 can be achieved in a building with low supply temperatures of 35°C [13]. Thus, the system can achieve efficiencies as high as a GSHP without drilling for ground-source collectors.

Applications

An economic application of such a system is mainly suitable for new and energy efficient buildings. For existing buildings, the system can be applied as an additional heating system with an existing boiler. Since the scalability depends on the available roof-top area, it can be also applied to non-residential buildings such as retail and office buildings. An integration in cold district heating networks is also possible.

Reduction of air pollution and GHG

Heat pumps do not produce direct emissions. The reduction of GHG emissions depends on the share of self-produced electricity from the PV part of the PVT, the overall efficiency of the heat pump and the GHG emissions of the additional electricity required from the grid. Such a system with a smart energy management system can also consider real-time emission factors of the grid in the decentralised operation scheduling. The thermal part of the PVT contributes further to the decarbonisation of the system.

History and market development

Research on PVT collectors started as early as the early 1960s. Only in recent years, industry and market development research has regained interest, triggered by the decline in PV module prices and regulatory measures and subsidy programmes focusing on on-site renewable production. Since 2012, pilot projects in Germany have

been developing new collector concepts for optimum integration with a heat pump. In 2018, a commercial batch production of the PVT collector as heat collector for a brine-water heat pump was launched [15]. Another large applied research and market development project concerning PVT collectors supported by the Federal Ministry for Economic Affairs and Energy started at the beginning of 2019 [16].

PVT collectors and integrated systems with heat pumps are still at an early market development stage. The commercially available systems, though, are promising.

Economics and business cases in Germany

According to heating system online portals, PVT collector prices range from 600 to 1200 € per panel, including installation [17]. As the technology is not yet very widespread, it is difficult to obtain reliable market data. A publication of a PVT-heat pump integration project compares the integrated PVT-heat pump and thermal storage system with a system consisting of an air source heat pump, PV module and thermal storage for a new single-family house with heat demand of about 10 MWh. The results show that the investment costs of the PVT system are 7.5% higher in the case of a batch production of 20 000 m² per year [13].

The integrated system is supported by the same funding schemes and regulative instruments as individual heat pump systems (see chapters 4.2 and 4.3).

Figure 23: Storing excess heat from PV in geothermal probes

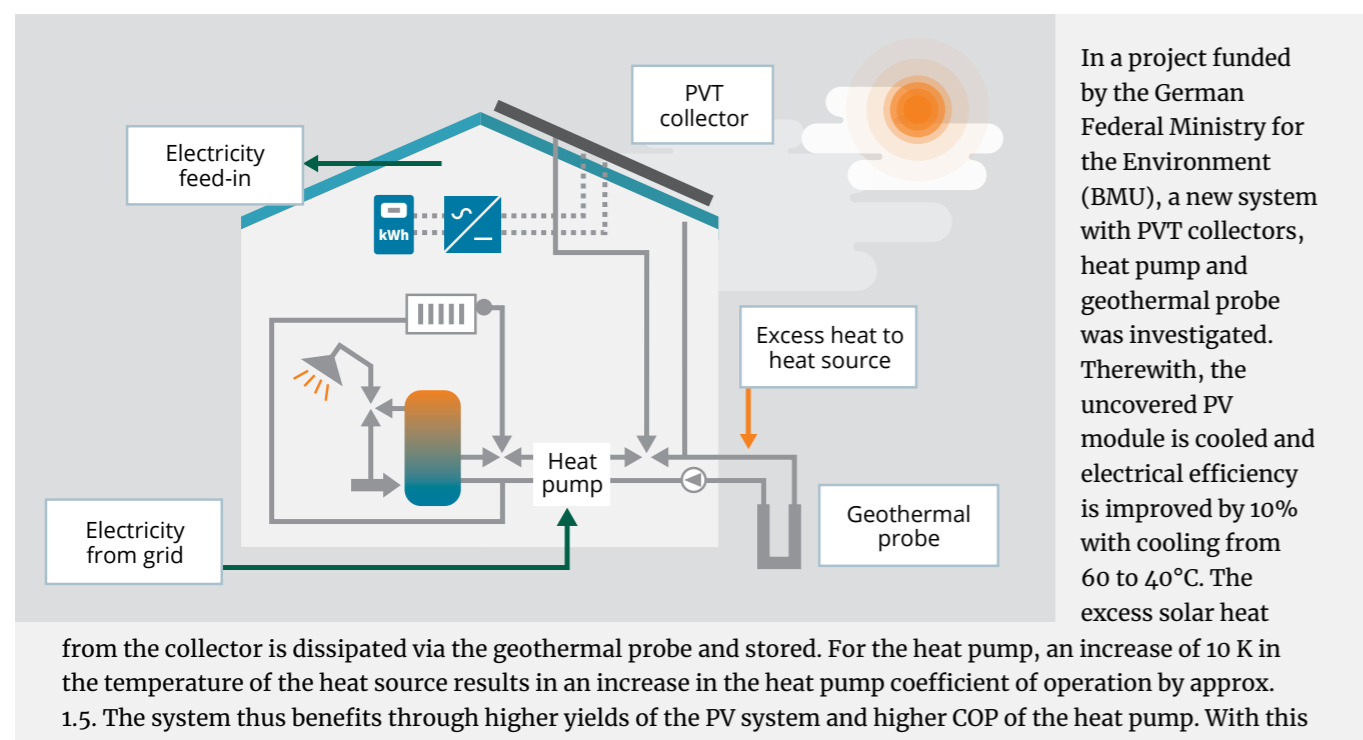

innovative concept, a pilot plant in the city of Dreieich achieves complete renewable coverage of energy demand. In the system designed for a larger residential building, fields with and without cooling are used to compare performance.

The single-family house with 280 m² of living area and panel heating is equipped with 39 m² of PVT collector surface, two PV reference modules without cooling (3.2 m²) as well as a 12 kW heat pump connected to three 75 m geothermal probes. In the two years of operation measured, the heat pump achieved a very good performance with an annual coefficient of performance of 4.2. The collectors produced a thermal yield of about 450 kWh. With the solar excess heat in summer, the PVT collector regenerates the heat source. The combined system delivers a 4% higher PV energy production - up to 10% is possible in special installation situations or under other climatic conditions. The use of heat pumps results in an electricity saving of 10%. Source: [18]

Pilot plant produces electricity and heats indoor

Ideas for pilot installations in China

Hybrid solutions using PVT and heat pumps do not only improve and stabilise the output temperature of solar thermal conversion, but further improve photoelectric efficiency by lowering operating temperatures and hence improving the overall efficiency of the system. Additionally, such systems help to tackle issues of unstable operation of heat pumps in winter. Such systems can cover a building's total energy demand by supplying power, heating, domestic hot water, and cooling in a flexible and renewable manner. Pilot projects in China could focus on single-family houses and swimming pools (as described above) and be applied to existing distributed PV solutions in industry parks, factories, hotels, or office buildings.

4.5 Waste water heat recovery systems

Waste water heat exchangers in combination with heat pumps enable the use of the thermal energy of waste water for heating or cooling and domestic hot water preparation. The energetic use of waste water stemming from buildings can be done in three different ways: (1) by using the untreated waste water upstream of the waste water treatment plant in the sewer, (2) by using it directly in the waste water treatment plant, and (3) by using the treated waste water downstream of the waste water treatment plant.

Even if the heat extraction in the sewage treatment plant or after the sewage treatment plant is technically feasible, there are often no heat consumers in the immediate vicinity, as sewage treatment plants are usually situated at a spatial distance from settlements bodies. Therefore, the thermal use of the waste water before entering the sewage treatment plant is often most

swimming pool: In this PVT plant, excess heat from the photovoltaic modules heats the air for an indoor swimming pool in Kümmerbruck, Bavaria, via a special absorber system. The system was developed by the Amberg-Weiden University of Applied Sciences and Grammer Solar, and supported by the Bavarian State Ministry of Economic Affairs, Infrastructure, Transport and Technology. The photovoltaic module area of 130 m² delivers an electrical output of 16 kW_{peak}. The PV modules are cooled from the rear via air flow. The excess heat of approximately 50 kW_{peak} reduces the ventilation heat requirement of the indoor swimming pool. The PV energy yield was more than 5% higher than that of an uncooled comparable system. The system is designed with electricity generation as a priority, operating at the optimum of photovoltaics, not at the optimum of solar thermal energy. Such hybrid collectors can supply large amounts of air at a relatively low temperature level. It works best for the year-round supply for customers such as drying plants and swimming pools or preheating air in process heat plants. Source: [18]

promising from an economic point of view.

The implementation of waste water heat recovery systems is most beneficial in areas with high occurrence of high-temperature waste water. Since the treatment capacity of sewage treatment plants decreases with the waste water temperature, the inflow temperature at the sewage treatment plant site should not be significantly lower than the design temperature. Therefore, the permitted temperature difference in the waste water heat exchanger is limited. Furthermore, the higher the waste water temperature and the lower the required flow temperature of the buildings, the higher the efficiency of the systems. Thus, sewage canals with a minimum temperature above 10°C in the heating period in winter are recommended for waste water heat exchangers and the permissible temperature spread can be up to 4 K.

Application	use of waste water in the sewage system for space heating or cooling and domestic hot water supply or cooling in residential and non-residential buildings through the use of heat exchangers and heat pumps.
Target group / customers	large residential and non-residential buildings in urban areas near sewage pipes with high occurrence of high-temperature waste water.
Advantages	<ul style="list-style-type: none"> usage of thermal energy in waste water proven technology better performance of heat pumps compared to other heat sources (e.g. ambient air or rivers) economically viable in areas with a high volume of waste water reduction of GHG emissions
Challenges	<ul style="list-style-type: none"> performance is best in new buildings, as the temperatures required for heating are lower not suitable for single-family houses agreement between sewer network operator and operator of waste water heat recovery system required
Costs	<ul style="list-style-type: none"> depends on the volume of waste water and the characteristics of the supplied building stock, the cost for economically viable examples vary from 5.5 ct€/kWh in the building stock to up to 15 ct€/kWh in new buildings⁵.
Specific CO₂ emissions	100 – 130 g/kWh with the current German electricity mix (570 g/kWh _{el})

Technology description

Types of heat exchangers

Waste water heat recovery systems combine a heat pump with special heat exchangers in the sewer. Special heat exchangers are required to be able to use waste water as a heat source. For this purpose, either sewage canal heat exchangers or bypass heat exchangers can be used Figure 24 displays different types of heat exchangers.

Sewage canal heat exchangers are manufactured as prefabricated elements according to the existing sewage profile and can then be retrofitted in a sewer with a nominal diameter of 400 mm or larger. For new sewer

Figure 25: Principle of a waste water heat recovery system

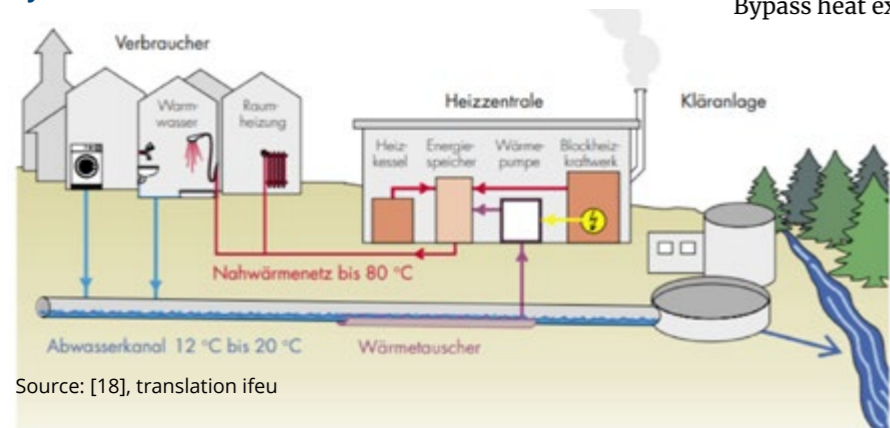

Source: [18], translation ifeu

Figure 24: Sewage canal heat exchanger (left) and bypass heat exchanger (right)



Source: [4] and [5]

constructions, elements with factory-integrated heat exchangers can be used, thus exploiting cost synergies. The heat exchanger surfaces are made of a material with high thermal conductivity and are usually double-layered for the flow of an intermediate medium. The length of a heat exchanger can easily be 200-300 m [6].

Bypass heat exchangers extract a part of the waste water flow, whereby the heat is transferred via plate or double-tube heat exchangers. The installation is therefore positioned outside the sewer. The advantages compared to sewage canal heat exchangers are that they do not require intervention in the sewer itself and that they can be installed regardless from sewer size and geometry. However, due to the the large initial investments, they are only suitable for larger systems [5].

⁵ The heat costs of different areas cannot be directly compared due to the different framework conditions - mainly the characteristics of the building stock (existing vs new buildings). The decision is always based on the cost of a reference technology that could be used at the location. The cost of the reference technology in the mentioned new building district is above 15 cents/kWh due to the low heat requirement.

Capacity and yield

The heat transfer capacity of the heat exchanger depends on the surface of the heat exchanger, the temperature difference of the heat exchanger medium and the waste water as well as on the thermal transmittance k. Typically, the heat transfer coefficient varies from 0,6 to 0,9 kW/m² K [7]. Thus, at a practicable temperature difference of 3-4 K, the output with which the heat is extracted from the waste water is between 2 and 4 kW per m² (ibid.). Projects realised show a range of installed capacities for heating in Germany from 12 kW to 2,100 kW (average 160 kW) and cooling from 136 kW to 1,000 kW with an average of 383 kW [8].

Applications

In order to harness the energy of waste water in buildings, either direct integration via a central heating system in the building or integration via cold or warm local heating networks is possible. In many cases, waste water energy is used in large buildings or districts in the immediate vicinity of sewers. The use in single-family

houses is usually not viable because of the investment costs.

By using heat pumps, temperatures can be reached that are sufficient for heating and cooling purposes in buildings and domestic hot water preparation, but the temperatures are not sufficient for process heat. Due to the increased efficiency of the heat pump at lower inflow temperatures and economies of scale, the use of waste water recovery systems makes sense especially in densely populated areas with efficient buildings.

Important combinations with other technologies

Due to insufficient temperatures of waste water for the direct use in buildings, a combination with heat pumps or other technologies is required. Most of the realised projects in Germany use heat pumps at least in bivalent operation in order to be able to guarantee higher annual coefficients of performance. Thus, waste water heat recovery systems and heat pumps are often combined with combined heat and power units (CHP) or other peak load technologies.

Figure 26: Concept for heating and cooling at IKEA Lichtenberg in Hamburg

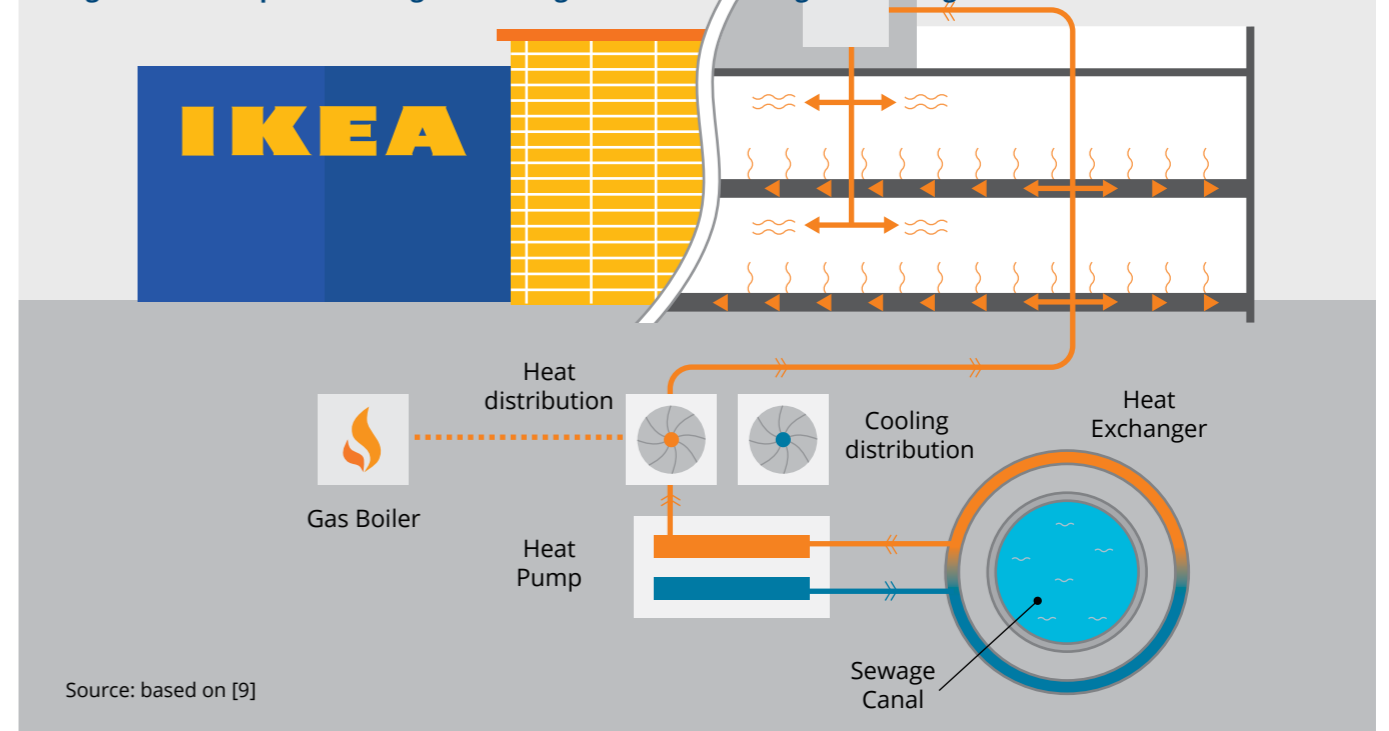

Source: based on [9]

Ikea - Hamburg Lichtenberg

The furniture store IKEA has realised a system for the use of energy from waste water due to the immediate proximity to the waste water pressure pipe when they opened a new store (43,000 m²) in Hamburg-Lichtenberg. During the planning phase, one requirement was that there should be no hydraulic influence on the waste water flow, which led to the use of a bypass heat exchanger that cools the waste water by 2 K. Three heat pumps and an additional gas boiler for peak load were installed. With this design, the energy from waste water can be used for heating in winter and cooling in summer [9].

Reduction of air pollution and GHG

There are no direct emissions of GHG or pollutants from the usage of waste water heat recovery systems in the sewage system. Therefore, the systems contribute significantly to local reductions. Electricity is needed for powering the heat pump. The heat pump efficiency depends on the required temperature level. Various studies show that reaching annual to reach annual coefficients of performance of around 4.5 ([2], [10], [11]). Thus, the potential to reduce air pollution and GHG strongly depends on the electricity mix used for heat pumps and the replaced energy carrier.

Analyses for Germany show that, assuming CO₂-emissions for electricity amount to 489 g/kWh and the bivalent use of heat pumps and gas boilers, the resulting GHG savings vary from 26% to 89% depending on the building category and available sewage water [12]⁶.

History and market development

The first energetic use of municipal waste water as a heat source in Germany dates back to 1982, when the first plant for generating energy from waste water was installed in Esslingen/Baden-Wuerttemberg. However, due to technical difficulties with the heat pump itself, the plant was taken out of operation again after a short time. In the context of a research project, the reactivation of the heat pump was examined in 2010 [2]. In Butz and Müller [3], the authors classify the technologies for exploitation of heat in waste water in three generations: the first generation was the one built at the same time as the first installation in Esslingen. Three systems were built between 2003 and 2005, which were classified as the second generation. All systems built since 2006 are classified as third generation technologies. One of the leading sewage heat exchanger manufacturers has installed 79 heat exchangers in the period from 2007 to January 2019 [8].

Economics and business cases in Germany

A general statement on the economic viability of energy from waste water for space heating and domestic hot water supply is only possible to a limited extent due to the different framework conditions of individual districts. The explicit evaluation of a specific project always requires the consideration of the individual circumstances. The economic viability depends on the economic viability of the local district heating network, thus:

- The higher the heat demand density, the lower the installation costs of the local heating network [1].
- The higher the heat demand density, the lower the network losses [13].
- Lower flow temperatures and smaller local heating networks reduce operating costs of heat pumps and network losses [14].

Furthermore, the costs explicitly depend on the electricity price including all taxes and levies and the economic viability is also reliant on the costs of competing technologies.

Realised projects in Germany show the following possible range of costs: a heat exchanger manufacturer reports costs of 7.2 ct€/kWh at suitable locations [19] including costs for installation, sewage canal heat exchanger, heat pump and operation costs. In a feasibility study in Baden-Wuerttemberg in Germany, the range of heat production costs was also listed as a function of the usable waste water flow and fluctuated from around 5.5 ct€/kWh at 200 l/s to almost 8 ct€/kWh at 20 l/s [14]. The heat production costs of various alternatives were also presented for the low-energy housing quarter NeckarPark in Stuttgart, whereby the combination of waste water heat and CHP is the most favourable option (15 ct€/kWh), and was therefore more favourable than the monovalent operation

of the heat pump (18.7 ct€/kWh), gas condensing boiler (16.1 ct€/kWh) and large CHP (15.1 ct€/kWh) [10].

In areas with high waste water volumes (e.g. besides the main sewage canal), energy from waste water can already be economically viable. One major problem is that the knowledge of the potential of this waste heat source is not widespread in the municipal context. Nationwide, no mapped information on sewer networks and the corresponding sewage volume is digitally available. This means, that private builders and energy service providers, who normally operate the waste water heat recovery systems, often lack the planning basis. In addition, the investment costs for the technology are high and represent an initial barrier.

A very good trigger point for such a system can be the integrated planning of new districts retrofittings of sewage systems in order to integrate such heat exchangers into local heating systems from the very beginning.

The installation of systems for heat generation or heat recovery in the public sewage systems, especially heat pumps and heat exchanger can currently be supported via two funding schemes:

- Energetic urban redevelopments [16]. An investment credit for sustainable investments in energy efficiency of municipal heating, cooling, water and sewage systems in urban districts, where the installation of heat exchangers and heat pumps can be funded.
- Heat pumps are also funded in the programme known as MAP⁷. Depending on the size of the heat pump, the funding amounts to 100 € / kW (Heat pumps < 100 kW) or is limited to 50,000 € for heat pumps (> 100 kW).

Figure 27: Sewage canal heat exchanger in Bretten



Bretten/Baden-Wuerttemberg - In Bretten/Baden-Wuerttemberg, a local heating network with heat pumps using energy from waste water was realised in 2009, which supplies several residential buildings, a sports hall and a grammar school with heat. The total heat demand of all buildings amounts to 1.8 GWh. The heat pump's coverage share is 25% [2]. The average temperature of the waste water is 11.6°C in the heating period. The annual GHG savings amount to 24% (129 t/a). The investment costs for this system are 920 thousand EUR, one third of which is needed for heat production. The annual heat price without subsidies in the year 2010 was 7.49 ct€/kWh

Figure 28: Sewage canal heat exchanger in NeckarPark



NeckarPark Stuttgart - In the NeckarPark, a newly constructed residential and commercial park in Stuttgart, 22 districts with more than 450 residential units are being developed, which will be supplied by locally available regenerative energy sources. Among other things, heat from waste water will be fed into a local heating network [10]. The area is located directly on a main sewer with a nominal di-iameter of N2100 and a dry weather discharge of 200 l/s and is therefore predestined for the use of energy from waste water. The concept provides for a heat exchanger extraction capacity of 2.1 MW.

Ideas for pilot installations in China

The advantages of utilising sewage waste heat are stable temperature levels throughout the year, usually between 10-20°C, largely independent from outside conditions, and a high flow rate. Waste water is the largest available low-temperature heat source in urban areas. Hence, waste water heat recovery systems can extract heat from the sewage for heating and cooling purposes of buildings and urban areas. Waste water heat recovery solutions provide the advantages of lower initial investments in comparison to ground source heat pumps and a more stable operation compared to air source heat pumps. Under normal circumstances, the COP of waste water heat recovery heat pumps ranges from 3.5 to 4.5.

Initially, pilot projects can be installed in many cities and large villages, preferably near large waste water collection pipelines. Waste water heat recovery systems could be used as supplementary heat sources for urban areas, providing heating, cooling, and domestic hot water to office buildings, shopping malls and

⁶ Assumed coefficient of performance for heat pumps: 4.5; analyses conducted for multi-family houses and office buildings; assumed flow rate of sewage water 15 l/s and 100 l/s; temperature difference amounting to 4 K.
⁷ MAP: Market Incentive Programme ("Marktanreizprogramm")

commercial buildings. Preferably, such projects should be considered and implemented during the overall planning and design phase of new development zones in China, to avoid additional costs associated with the retrofitting of existing sewage systems. Due to the generally large distance between urban areas and sewage treatment plants outside of cities, the utilization of untreated waste water for heat recovery provides the most promising development potentials.

The challenge for the utilization of bypass heat exchangers used in China today is an instable operation, as waste water contamination leads to blockages in pipelines and scaling of heat exchangers. Development efforts should focus on adequate pretreatment, anti-blocking, anti-scaling and anti-corrosion technologies. Sewage canal heat exchangers have the potential to avoid such problems. However, their application in existing sewage grids requires large (and expensive) retrofitting measures. Hence, such solutions should be considered in the initial planning and construction stages of district heating and sewage systems.

4.6 Bioenergy villages

The idea behind the German concept of “bioenergy villages” is to cover at least half of a village’s heat and electricity demand with regionally produced bioenergy. Bioenergy plants (biomass boilers or biomass CHP) installed in such villages are (at least partly) owned by local heat customers or local farmers. Sustainably provided biomass stems from the immediate surroundings, which increases local added value. Additionally, energy efficiency and energy saving measures are regularly checked and implemented. The generation of heat from biomass can be supplemented by using other renewable energy sources such as large solar collector fields (see chapter 4.7).

History and market development

The first definition of a bioenergy village is based on the project group “Bioenergy Villages” [4], where a bioenergy village was defined using the following criteria:

- The amount of electricity generated from biomass must (at least) cover local electricity consumption.
- At least half of the village’s heat demand is covered by biomass. Cogeneration should be chosen as means of a highly energy-efficient energy system.
- During planning and setup of the bioenergy village, the local population is actively involved in the planning and decision-making process. More than 50% of the village’s bioenergy plants are owned by local heat customers and farmers supplying biomass.

On the other hand, the Agency for Renewable Resources (Fachagentur Nachwachsende Rohstoffe e.V. FNR) provides a much broader interpretation of bioenergy villages:

- A bioenergy village covers at least 50% of its electricity and heat demand from regionally produced bioenergy.
- Citizens are involved in the decision-making processes and actively support the idea of the bioenergy village. The bioenergy facilities are at least partially owned by local heat customers or farmers. The sustainably provided biomass stems from the immediate surroundings.
- The generation of heat and electricity from biomass can be complemented by using other renewable energies.

The concept of bioenergy villages in Germany was first introduced in 2005. Until 2018, 151 communities have been founded and 43 are in development [2]. Even though the concept was first introduced in 2005, “bioenergy villages” have already existed before 2005. Around 65% of bioenergy villages have been established between 2005 and 2011.

Originally, the establishment of bioenergy communities was closely linked to the German Renewable Energy Sources Act (EEG), which supported energy production from biomass or biogas. However, the support for biomass power generation was reduced in the EEG’s latest amendments. Despite the declining legislative support, the establishment of bioenergy villages is still possible today.

Application	use of locally produced agricultural residues for heat generation with the goal of covering at least 50% of local space heating and hot water demand
Target group / customers	agricultural and rural areas, villages
Advantages	<ul style="list-style-type: none"> • reduction of GHG emissions, • proven technology, • structural change and development in rural areas through improved quality of life, local identity and village community, • reduced import dependency on fossil fuel suppliers.
Challenges	<ul style="list-style-type: none"> • Increased competition between cultivation of land for food and energy crops, • Increased dependency on individual farmers, • Intensive cultivation of the soil with monocultures can lead to environmental problems.
Costs	Levelised cost of heating (LCOH) from biomass heat plants vary between 8 ct€/kWh and 11 ct€/kWh. Half of the costs (49%) can be allocated to variable costs (such as costs for fuels, auxiliary energy, ash disposal and other operating materials). 13% are fixed operation and maintenance costs (costs for personnel, emission measurements, maintenance contracts) and 37% are investment related costs [1].

Technology description

Figure 29 presents the material flows in a bioenergy village. In addition to heat generation, these communities can produce electricity and biogas from the local agricultural residues.

The cornerstone of a bioenergy village is the local heating network. Local heating networks make use of the synergies provided by short pipe routes, few road crossings and independent operation through the neighbourhood. This promises good conditions for low heat losses in the pipeline network. The neighbourhood takes its energy supply into its own hands, which leads to a high degree of identification with the plant and a self-interest in its economical operation. Furthermore, the local heating networks improve the economic viability of biomass boilers and make it possible to connect additional renewable heat sources such as large-scale solar thermal to be connect. In some cases, under favourable economic conditions, the local heating network can be replaced by a biogas network, which connects the biogas plants with decentral gas boilers or micro-CHP units.

Figure 29 Material flows in a bioenergy village

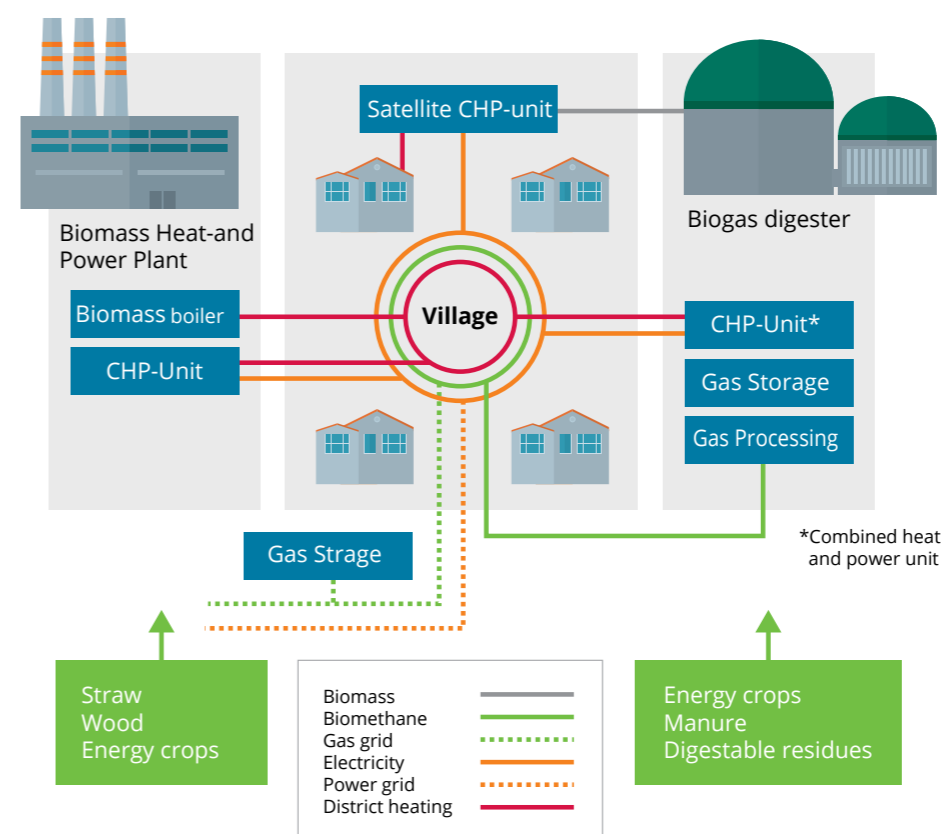

Source: FNR 2019 [6]

Capacity and yield

The typical heat generation capacity in bioenergy villages lies below 4,000 kWth. Figure 30 presents the installed capacities of wood chip boilers in 80 bioenergy communities. The energy efficiency of biomass boilers ranges between 75% and 85%.

Applications

Bioenergy villages can be scaled from small communities with 50 households up to more than 500 households. Furthermore, the application of biomass villages/communities is not only constrained to heat generation but applies also to the generation of electricity and biogas. The combination with other renewable technologies such as solar thermal, PV, wind and hydro plants has been implemented in more than 137 cases in Germany.

Figure 30 Installed thermal capacities (kW) of wood chip boilers in 80 bioenergy villages

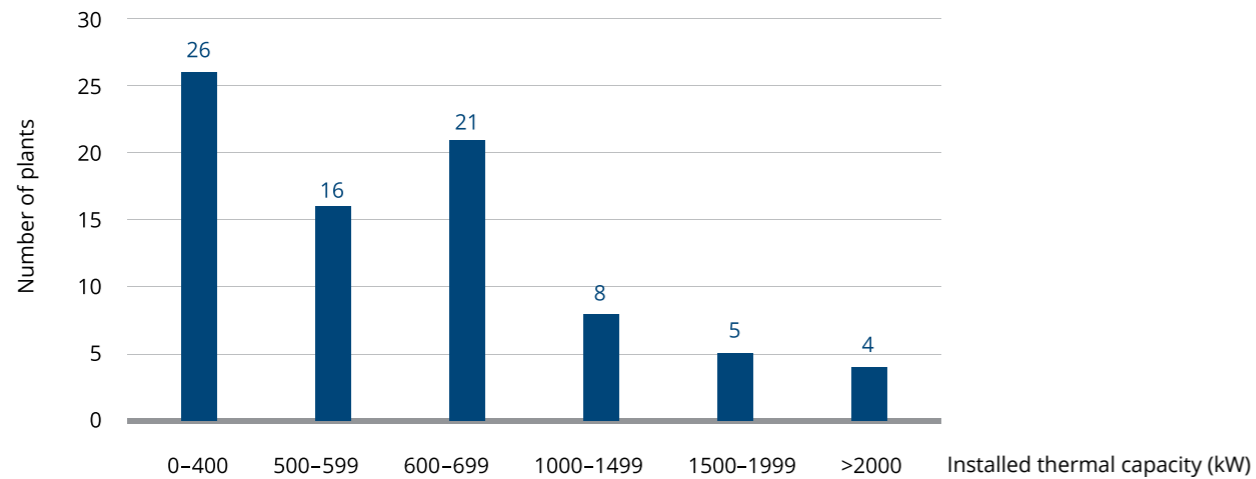

Source: ibeg 2017 [5]

Figure 31 Combination of biomass plants with other renewable energy technologies

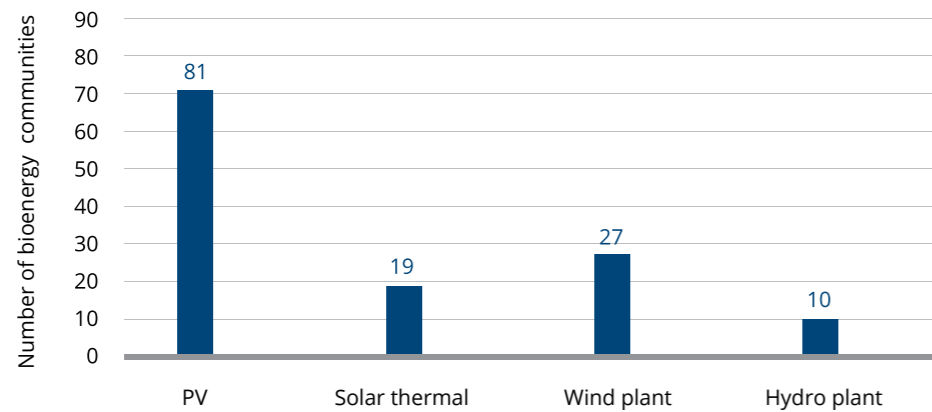

Source: ibeg 2017 [5]

Reduction of air pollution and GHG

Burning biomass releases carbon dioxide (CO₂) into the atmosphere. However, the plants, which are the source of biomass for energy production, capture almost the same amount of CO₂ through photo-synthesis while growing as is released when their biomass is burned. This can

make biomass a carbon-neutral energy source. Concerns have been raised regarding the respect to the particle and NOx emissions of biomass boilers, if operated by inexperienced or untrained users (see chapter 4.1). Figure 32 presents the equivalent CO₂ emissions per produced kWh_{th} for different heat supply solutions.

Figure 32 Specific GHG emissions of different heat supply technologies

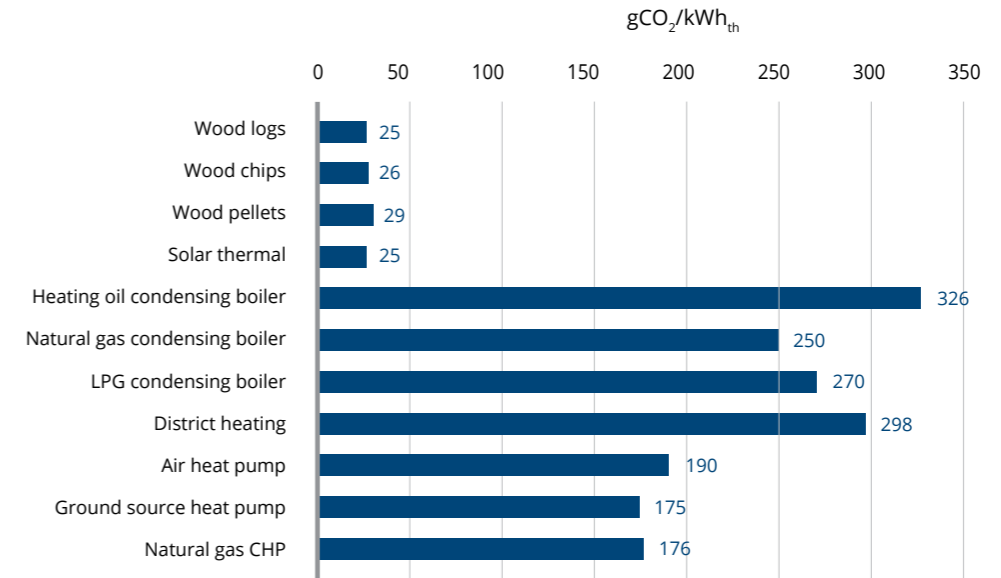

Source: FNR, 2018 based on IER Universität Stuttgart 2016 (based on GEMIS, Version 4.94) [6]

Economics and business cases in Germany

The investment costs for bioenergy villages vary depending on the type of biomass plant, the size of the local heat network, the type of other renewable energy technologies used, and the size and type of heat

storage units. Figure 35 depicts the specific investment costs of biomass fired boilers. As stated above, the total investments for a bioenergy village depends on the local conditions and other technologies implemented.

Figure 33: Bioenergy village Büssigen



One innovative example of a bioenergy village is Büssigen on the Upper Rhine. A local heating network (approx. 5 km long) and 100 transfer stations are supplied by two wood chip boilers (900 kW + 450 kW), oil boilers (750 kW) and buffer storage (100 m³). As a special feature, a solar collector field with a collector area of around 1,000 m² was erected instead of the usual biogas plant. The innovation regarding the planned bioenergy village lies in the integration of solar thermal heat generation into a large renewable local heating network. So far, such concepts had not been realised in Germany because heat supplied by CHP plants, which are cross subsidised via the EEG (CHP bonus), are significantly cheaper. Similar projects are only known from Denmark and Austria. The project's total investment amounts to 3.5 million EUR.

Figure 34: Bioenergy village Randegg



Another example is the Randegg district of Gottmadingen, where a large pellet boiler had already been in operation at the Randegg Ottilienquelle (700 kW). It has considerable free performance potential, as it was only operated during the production times of a large bottle washing plant. Since this process mainly takes place in summer and during the day and there is a heating demand for adjacent residential areas, it is possible to better utilise the plant throughout the year. In addition to a large local heating network with a length of around 4 km, a wood chip boiler with a firing capacity of approx. 1 MW for the base load will be installed. The existing pellet boiler is integrated into the overall system as an emergency and peak load boiler. In addition, from July 2018 onwards, the concept was extended by adding a solar area of around 2,400 m² next to the central heating system. The collector area will cover around 20% of the annual heating requirement. This also contributes to a further increase in the efficiency of the system. In total, the project can save around 1,000 tonnes of CO₂ annually.

Figure 35 Specific investment costs of automatically stoked biomass-fired boilers, fully assembled, including ash removal, air and flue gas system, and flue gas cleaning

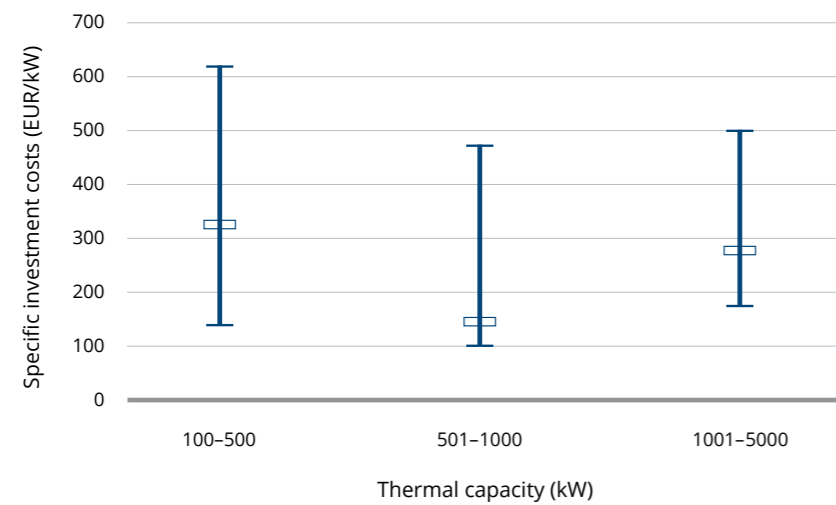

Source: FNR (2014)

Ideas for pilot installations in China

Despite the decreasing trend of people living in rural regions in China (from 53% of the population in 2008 to 40% of the population in 2018 [3]) the potential of biomass communities is still large and partially untapped. The estimated average biomass potential from 2000 to 2009 in China is around 700 million tons with a bioenergy potential of 7.4 EJ/year [7] or around 6% of the total energy demand of 132 EJ in 2018 (Enerdata).

Despite the very small annual fluctuation of crop residues (estimated at 1.2%), there is an enormous imbalance in spatial distribution. The most suitable administrative regions for biomass communities are the provinces Henan, Shandong, Hebei and Jilin (Figure 36).

The initial investment costs of biomass boilers are equivalent to those of gas boilers and lower than those of coal-fired boilers. At present, the market price of biomass fuels in China is about 900 RMB/tonne with an average heating value of 16-19MJ/kg. The operating costs, however, are higher than the costs of coal boilers, but still lower than those of gas boilers. Especially in northeast China, in areas with cold winter climates and high heating prices for residential and non-residential customers, biomass-based solutions offer a good development perspective. In areas with low heating costs, a certain amount of financial support by the government is necessary to implement such solutions. The German concept of bioenergy villages offers advantages for the onsite consumption of biomass, hence cutting transport and fuel costs.

Pilot projects for bioenergy villages in China should focus on newly built villages or communities and could go hand-in-hand with government policies for “new rural construction” and “beautiful villages”. Simultaneously, attention should be paid to increasing the energy efficiency of buildings in model villages. Village committees could act as owners of bioenergy systems with public-private-partnerships being the basic business models for construction and operation. Such bioenergy villages could be combined with other renewable energy technologies, such as solar thermal fields, to fully utilise the abundant spatial resources of rural areas and enhance local energy security. Participants in pilot projects should pay attention to controlling particulate matter and NO_x emissions to meet local environmental protection standards.

Figure 36 Spatial distribution (100*100 m) of net crop residues in China in 2009

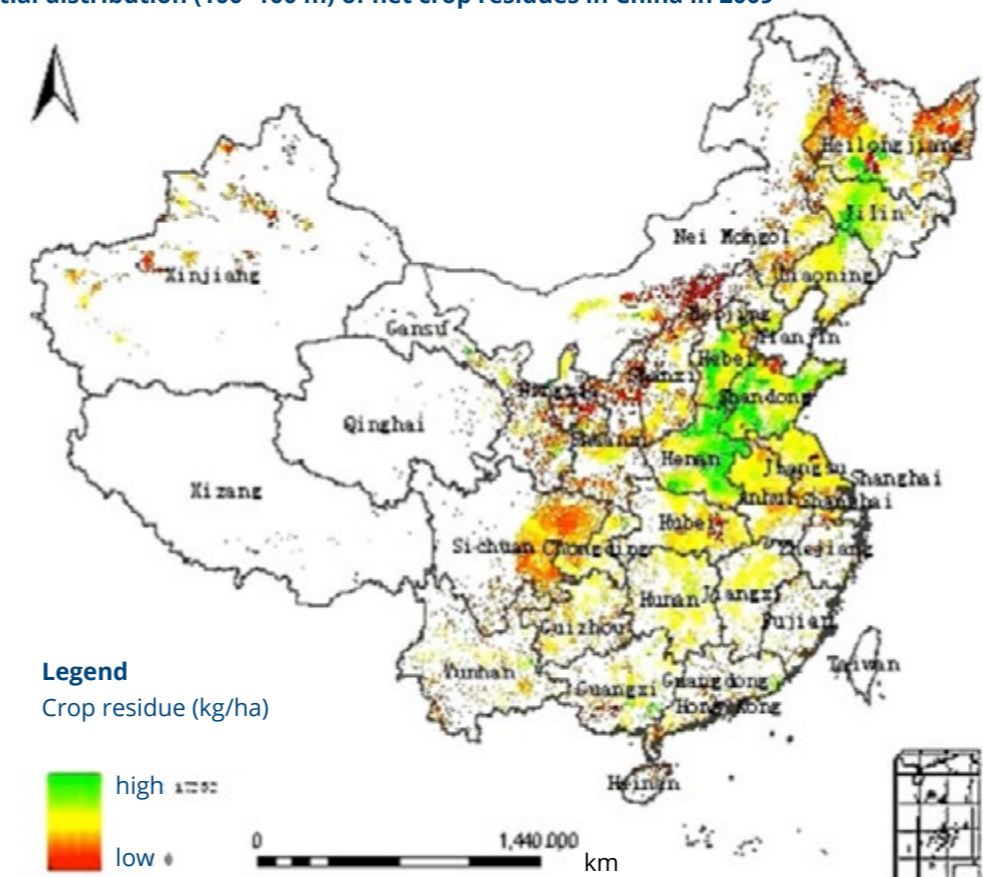

Source: Jiang et. Al 2012 [7]

4.7 Large solar collector fields

Technology description

Solarthermal collectors are devices to transform solar radiation into heat. The heat generated in the absorber is transported via a fluid (mostly water with antifreeze liquid) to the place where the heat is used. There are two main types of collectors: flat plate collectors (FPC) and evacuated tubular collectors (ETC). In FPC, heat losses from the absorber to the ambient air are prevented at the front side by a transparent cover (mostly glass) and at the backside by a layer of insulation. In ETC the absorber is placed in an evacuated glass tube that prevents losses very effectively. Apart from the share of heat losses, the collector efficiency depends on the collector's optical properties. Here, FPCs are more advantageous. Better insulated ETCs only produce higher yields at higher temperatures.

Large collector fields, exceeding several hundred square metres, were first realised in Denmark, the largest one

being the system in Silkeborg with 156,000 m². This technology is increasingly being employed in Germany, with several manufactures and service providers focussing on it.

The typical yields of large solar collector fields for district heating lie in the range of 500 kWh/(m²*a). Given a yearly solar irradiation in the collector plane of about 1,250 kWh/(m²*a), this corresponds to a yearly mean efficiency of 40% [1].

The typical solar fractions of solar district heating systems are in the range of 20% (the other 80% of the heat demand are provided by other heat sources), using medium sized storage systems. This value can be increased by using large storage systems. Below a solar fraction of 10%, no or only small storage solutions are needed. The yield decreases with increasing temperature demand.

Application	production of low and medium temperature heat for feed-in into district heat and industrial process heat. This solution is often applied in small cities with rural surroundings but is increasingly being used in large existing district heating systems. It is often applied in combination with large seasonal storage solutions.
Target group / customers	utilities and district heat operators, large process heat consumers
Advantages	<ul style="list-style-type: none"> • economic transformation of fossil fuel to renewable district heat, • high scalability, • no fuels required.
Challenges	<ul style="list-style-type: none"> • a large area is necessary for the collector installation, • with increasing solar shares, seasonal energy storage is required.
Costs	depending on the investment costs. LCOH of around 3.5 ct€/kWhth under German solar irradiation conditions and construction costs.
Specific CO₂ emissions	15 – 35 g/kWh

Applications

Solar thermal collectors are used to produce heat for domestic hot water, for space heating, for district heat and for process heat (with ETCs up to about 150°C). Almost all larger installations are installed in connection with district heat. In many cases, these district heating networks are located in rural villages, where enough space for the collector field is available. In Germany, the collectors have often been installed together with a new district heating system.

In the course of the last years, large collector fields have

also been installed near larger cities. The large collector fields do not necessarily have to be installed very close to the consumers. As a rule of thumb, the heat losses occurring on the heat transport lines are acceptable, as long as the distance between the collector field and the settlement is less than twice the diameter of the settlement.

Seasonal storage

During winter, when much space heating is needed, the solar thermal collectors produce only a small amount of heat. Thus, higher solar fractions are only possible if

storage systems are used. For solar fractions above 30%, seasonal storages are needed. Some of the larger systems achieve a solar fraction of about 40%, combining for instance a 37,600 m² collector field with a seasonal storage with a water volume of 63.000 m³. Only one sixth of the total investment costs for this particular solar project of 14.13 million € was caused by the seasonal storage.

There is a great variety of technical concepts to realise

Seasonal heat storages can not only be used to increase the share of solar energy; they also provide a means for “sector coupling”. This becomes increasingly important with an increasing share of volatile electricity from PV and wind power in the grid, as is the case in Germany. If there is abundant electricity from renewables in the grid, it can be used to heat up the seasonal storage. Heat storage in water is by far cheaper than electricity storage in batteries. The heating of the water can be done directly using a simple electric heater or through a more efficient heat pump.

In future, it will also be possible to use seasonal storages as electricity storages. Excess electricity may be used in combination with a heat pump to increase the temperature of the seasonal storage's upper level (i.e. up to 150°C).

Reduction of air pollution and GHG

Solarthermal collectors do not release emissions of GHG or other pollutants. From a life-cycle assessment point of view, the GHG emissions from the construction of the solar field are very low. During operation, electricity is needed to drive the controls and the pumps. However, the amount of electricity needed is very small in comparison to the solar heat gained.

Some pollution is caused by the production of the collectors. However, this pollution is low in comparison to the pollution avoided by not using any of the alternative heat producing possibilities. After about 1.5 years, the collectors have saved as much energy as was needed to produce them.

In small district heating systems, solar thermal collectors can help to switch off boilers in summer-time, when they only operate to produce hot water (or cooling). In wintertime, heat production from solar collectors – when seasonally stored – replaces bulk production from boilers. A heat pump can be connected to the storage to

seasonal storages, such as tank storage, pit storage, borehole storage and aquifer storage. The optimal storage concept depends on the local (e. g. geological) and technical conditions. Currently, the cheapest solution by far is the pit storage with a floating lid. Compared to other concepts, it has two disadvantages: first, the top of the storage is not accessible by cars or for other heavy loads and second there is no insulation of the bottom and the walls of the storage. Nevertheless, the measured yearly heat losses of the storage are in the order of 10% of the solar heat that was transferred into it.

Figure 37: The principle of a gravel pit seasonal storage

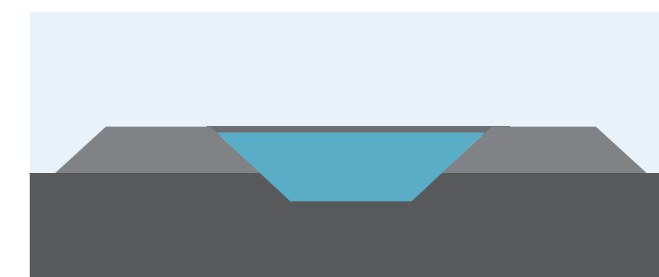

increase the share of solar heat that can be extracted from the storage. The exact emission reduction depends on the energy carrier and the technology that was replaced by solar energy in the central heating system. This may be coal, natural gas, oil or biomass.

History and market development

In Germany, there is an increasing interest in large collector fields and seasonal storage. Many research installations were realised at the beginning of this century. Because of the boom in Denmark, the interest in large solar installations has increased over the last years. The first ones were installed in villages where new district heating systems based on bioenergy had been realised. Here, the solar energy conserves the scarce resources of biomass. Now, several new plants feeding solar heat into existing district heating systems of cities are being built. The motivation for this development is that district heating must become eco-friendlier [1]. For 2020, more than 40 systems, equalling to around 100.000 m² of collector surface area, are expected to be installed in Germany, with a steep upward trend in the future years (the support schemes featured below explain this increase). Whereas the first systems were typically initiated by small district heat operators, “bioenergy villages” and energy cooperatives, increasingly large utilities enter this market. A driver for this development is the planned coal power plant phase-out to be completed by 2038. Today, coal power provides a large share of Germany's district heating. This heat source will be phased out step-by-step, requiring alternative heat sources for the supply of the heating systems.

Figure 38: ETC collectors in the field in Büsingen



Source: Photo: ifeu, M. Nast

The first commercial collector field to feed heat into a district heating network was installed in 2012 in Büsingen, a village with 1,300 inhabitants. Through about 1,000 m² of ETC collectors and a heat storage tank (100 m³) 12% of the heat demand of the network is covered by solar energy. The remaining part is provided by two wood chip boilers. 107 oil boilers in private and public buildings were substituted with the renewable district heating system.

Economics and business cases in Germany

The investment costs for large collector fields ($\geq 10,000$ m²) are in the range of 200 €/m². The yearly costs for electricity and maintenance are low. To produce one MWh of heat, the pumps to drive the field need only about 4 kWh of electricity. The costs for maintenance are in a similar range as for the electricity. Typically, the total costs for operation and maintenance are calculated at 0.15% of the initial investment.

As an example, the following figure shows the distribution of the total investment costs of 14.6 million € for one particular system for which such data is available. Apart from the costs for the collector field itself the investments for the seasonal storage, the operations building, heat transport lines from the collector field to the central heating plant in the centre of the settlement, a bio-oil boiler and a heat pump, which pumps heat from the colder to the hotter part of the storage, are depicted.

The corresponding heat costs are calculated with 6 ct€/kWh (interest rate 4%, calculated lifetime 20 years). The share of these costs that can be assigned to the collector field is 4 ct€/kWh. Considering that specific investments for larger projects (like in Silkeborg) are lower, the real

Figure 39: Installed large solar thermal fields in Germany as of August 2019

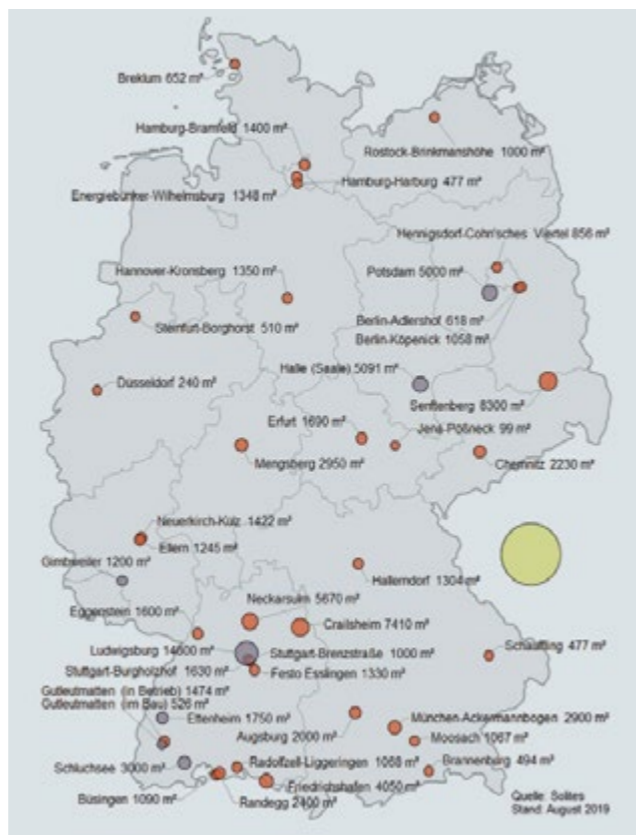

Source: [2]

Figure 40: FPC collectors in the field near Dronninglund



Source: Photo: ifeu, M. Nast

lifetime is longer and better financial conditions are available. Nowadays, the heat generation costs of the collector field drop to about 2 ct€/kWh.

Up until now, the collector fields in Germany have been significantly smaller than in Denmark. Additionally, the

Figure 41: Investment cost break down in a specific solar thermal collector field in Dronninglund (total cost: 14.6 million €)

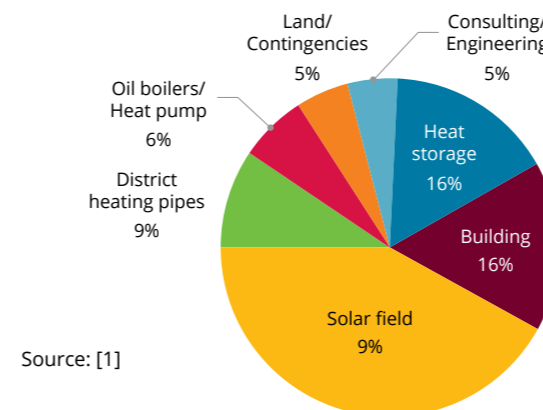

Source: [1]

Figure 42: ETC collectors in a field near Senftenberg



Source: Photo: R. Meißner, Ritter XL Solar

Since 2016, the largest German solar thermal installation has been in operation in Senftenberg (24,000 inhabitants). By means of 8,300 m² of ETC-collectors, 4% of the yearly heat demand of the district heating system is provided by solar energy, replacing an equivalent amount of heat from a lignite power plant. The system uses no storage at all. The temperatures in

quality requirements for the collectors are higher, since the flow temperatures in the German district heating networks are rather high. Thus, the costs of German collector fields are about twice the Danish costs.

The amount of solar irradiation in Germany and Denmark is comparable. In most parts of China, it is significantly higher – even in densely populated areas. This will lead to lower heat generation costs.

the district heating system are rather high. The collectors have to deliver temperatures above 85°C throughout the whole year. Nevertheless, a solar yield of 4 GWh is achieved, corresponding to 480 kWh/(m²*a). The plant replaces heat from a lignite fired combined heat and power plant (CHP) that has been closed down.

Ludwigsburg

In Ludwigsburg (93,000 inhabitants), the largest German solar collector field with an area of 14,800 m² of FPC collectors will become operational in 2020, replacing Senftenberg as the largest solar field. It will deliver 5,500 MWh of solar heat per year (corresponding to 370 kWh/a). The construction of a heat storage tank with a volume of 2,000 m³ has already started. The solar installation will be integrated into the large existing district heating system. It will replace mainly heat from a CHP-plant that is fired by woodchips. Thus, the CHP plant can be switched off during summer, when the prices for electricity are low due to high feed-in of electricity from PV-installations.

34 large collector fields feeding solar energy into district heating systems with a total collector area of 62,700 m² have been built in Germany. Until 2023, a doubling of the number of installations and a tripling of the collector area is expected.

In Germany, taxes on fossil energies that compete with solar heat are by far lower than in other countries, making the development of renewable alternatives for district heat more difficult. For compensation, various grants exist in favour of solar driven district heating systems:

- For collector fields that feed into a district heating system, a grant of 40% of the investment costs is provided. It may be increased to 50% if the energy produced is mainly used as process heat. Additionally, there are investment grants for the construction of renewable district heating systems. Here, a grant of 60 € per metre trench length is given and additionally 1,800 € per house service connection. The maximum grant for district heat is limited to 1,000,000 €. The grants are provided by the MAP (see chapter 1).
- Besides the MAP, another financing possibility exists: For complete district heating systems, a grant of 20% of the investment costs can be applied for. For small and medium-sized companies, the grant is increased to 30%. If some rather strict conditions are met, an extra bonus of 20% may be paid. Thus, in total a grant up to 50% is possible. The maximum grant is limited to 15 million €. In Germany, this programme is known as Wärmenetze 4.0 (Heat Grids 4.0).
- Additional grants may be paid by the different federal states. In the state of Baden-Wuerttemberg, an extra grant for the construction of district heating systems of 20% is available if some extra conditions are

fulfilled. The maximum grant is limited to 400,000 €. In Germany, this programme is known as VwV energieeffiziente Wärmenetze (energy efficiency heat grids).

- Another grant is possible in connection with the construction of an innovative CHP-plant. A CHP-plant is considered innovative, for instance, if the combined collector field produces at least 30% of the heat that the CHP-machines can produce in the course of 3,000 hours per year. The funding is allocated by means of open competitive bidding. Those plants that demand the lowest premium per kWh of produced electricity receive the money. The premium is limited to 12 ct €/kWhel. It is paid for a maximum of 45,000 full load hours of the CHP-plant. There is no maximum for the total sum of the premium. This promotion can result in attractive conditions for the financing of large solarthermal collector fields. This scheme can also finance large heat pumps, but not biomass and geothermal installations, which are funded in other schemes. In Germany, this promotion is known as KWK-Ausschreibungsverordnung (CHP Tendering Ordinance).

Typically, solar thermal installations are operated by utilities, which also run the district heating system itself. Some companies are considering starting a “solar thermal contracting service”, meaning that independent operators

Ideas for pilot installations in China

Solar thermal collectors are mature technologies and widely used for the supply of heat energy for domestic and industrial hot water, heating and cooling applications in China. China’s solar radiation resources are abundant, making solar thermal solutions suitable for application across the country. Current distributed applications focus on the supply of domestic hot water in residential buildings and hotels in small towns and rural areas. The application of large-scale solar thermal fields for centralized heating systems focuses on public facilities and large residential buildings, including schools, stadiums, hotels, etc. in large and medium-sized cities.

Economically, collectors perform best in climates with a high heating demand and high solar irradiation – especially during winter. Additionally, the existence of a district heating system is a prerequisite for the installation of a large collector field.

An example of pilot installations are large towns to the west of Beijing at altitudes above 1,000 m. There, the irradiation exceeds the German values by about 60% and the climate is cold (example: Datong city with 1.4 million inhabitants at an altitude of 1,200 m). A recommendation would be to consider these locations for pilot installations of large solar thermal collector fields.

Large-scale solar thermal fields are already in use in different areas of China. Demonstration projects include the 16,000 m² solar heating project for Shenyang Beiruan Library, Tibet University’s 20,000 m² solar heating project, the solar hot water project in Yuandian No. 2 Mine in Huaibei and the 11,600 m² solar heating project of Hebei University of Economics and Business. The main challenges for these projects are large investment costs in the initial construction stage and a lack of financial support policies.

plan, install and operate the solar thermal system and offer the solar heat to the district heating company. This would result in an interesting scaling effect because these companies can – in close cooperation with the

manufacturer or even carried out by the manufacturer – realise better purchasing conditions and accumulate technological knowledge and learning

4.8 Geothermal district heating

This case study focusses on geothermal district heating (GeoDH), which is the use of geothermal energy to heat up individual and commercial buildings, as well as for industry, through a distribution network. This

differentiates this technology from the technologies presented in sections 4.2 and 4.3 which focus on shallow geothermal energy.

Application	district heating
Target group / customers	municipalities, private heat grid operators
Advantages	<ul style="list-style-type: none"> • local and flexible renewable energy that can provide a constant base load, • proven technology, • relatively small space requirement, • low operating costs, • reduction of GHG emissions.
Challenges	<ul style="list-style-type: none"> • capital intensive, • favorable geothermal conditions necessary, • electricity consumption for pumps.
Costs	investment costs (Germany, in €): 100 million €, heat generation costs (Germany): 2-8 ct€/kWh.
Specific CO₂ emissions	16 – 79 g/kWh (depending on the electricity mix used for pumping) ⁸



Technology description

Types of geothermal energy usage

Depending on the depth, geothermal energy can be

divided into two types: shallow geothermal energy and deep geothermal energy [13]. The most common systems for shallow and deep geothermal energy are shown in Figure 43.

Figure 43: Different types of geothermal energy usage

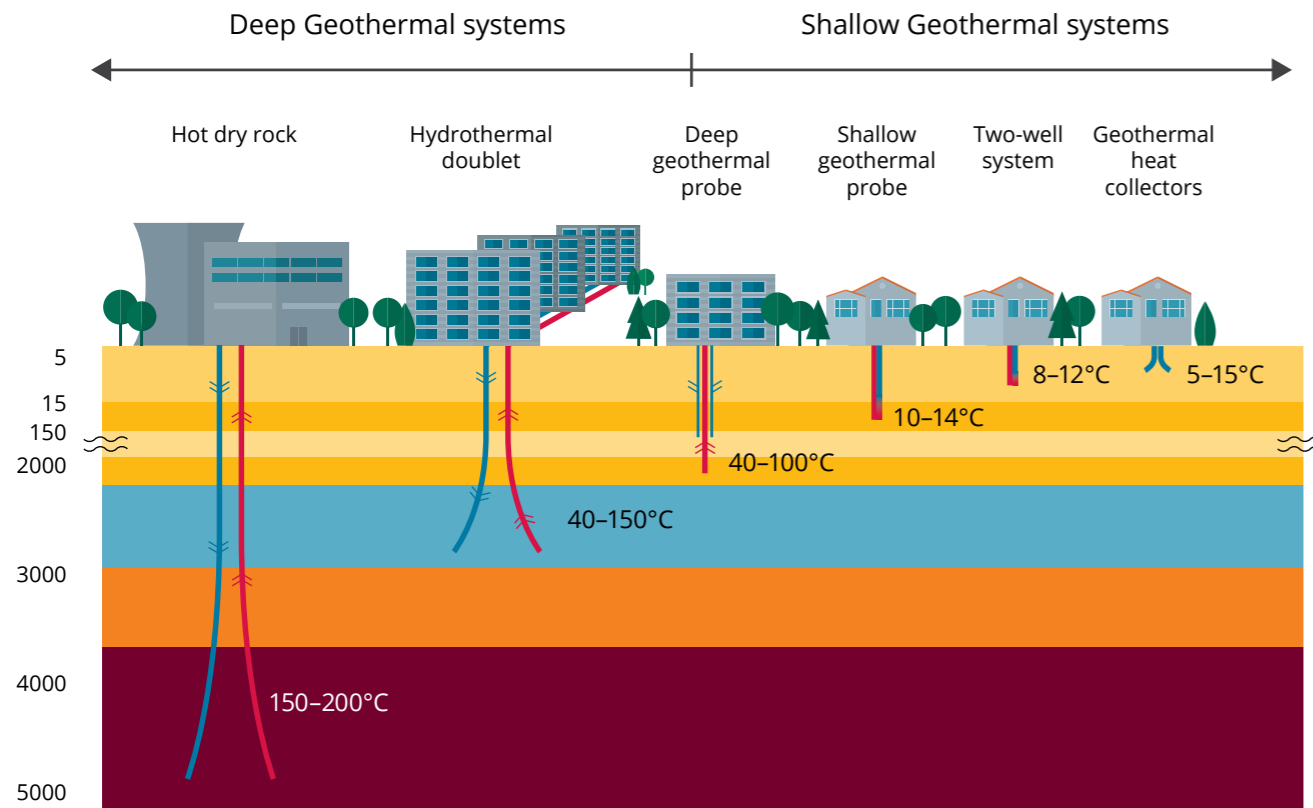

Source Photo: [13]

Shallow geothermal energy describes the use of geothermal heat up to a depth of approximately 400 m through wells, collectors and geothermal probes. The temperature levels range up to 25°C. Shallow geothermal energy can be used for space heating as well as for cooling purposes via a low-temperature DH network and a potentially reversible heat pump system [13].

Deep geothermal energy refers to the thermal use of the underground from 400 m depth and deeper. Deep geothermal energy can be utilised in open systems (petrothermal and hydrothermal doublets) as well as closed systems (deep geothermal probes). Deep geothermal probes offer the advantage of location independence without exploration risk, but they are

usually only economically viable if the borehole already exists. The decisive advantage of open systems is a significantly higher heat extraction (thermal output of approx. 1 to more than 50 MWth), compared to closed systems (max. several hundred kWth) [13].

The hot water is pumped to the surface through the production well, where a part of its heat energy is extracted via a heat exchanger. After heat extraction, the thermal water is usually pumped back to the ground through an injection well (Figure 44). The application of deep geothermal energy in DH systems requires the concurrence of a high geothermal potential and a high heat demand and heat density.

Figure 44: Deep geothermal plant in Munich

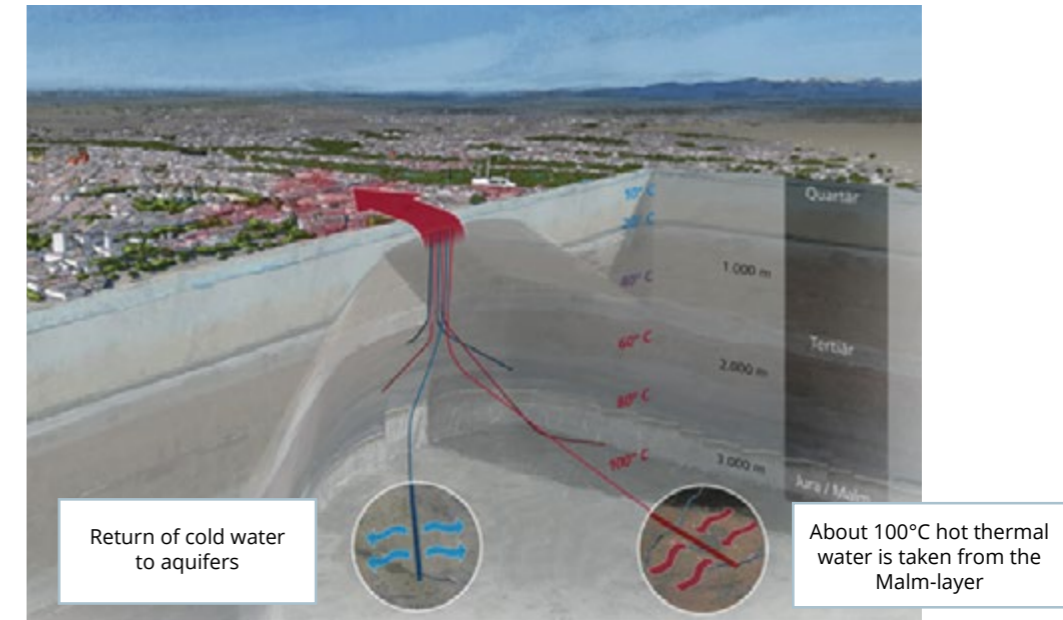

Source Photo: SWM

Capacities and yield

Typical capacities in Germany range from 2-40 MWth [2], with Munich reaching 50 MWth (see table below). Most of the plants have been built from the year 2010 onwards, showing the renewed interest in the

technology, though older plants exist. The share of geothermal DH in overall heat generation in German cities ranges from less than 15% to 100%.

Table 7: Existing geothermal district heating (DH) plants in Germany, individual sites [4]

Locality	Plant Name	Year commissioned	CHP	Cooling **	Geoth. capacity installed (MW _{th})	Total capacity installed (MW _{th})	2017 production + (GW _{th} /y) ^a geothermal ^b total	Geoth. share in total prod. (%)
Aschheim	Aschheim	2009	N	N (RI)	10.7	44.5	66.1 ^{a*} 89.0 ^{b*}	74.2
Erding	Erding	1998	N	N (RI)	7.7	48.8	35.6 ^{a*} 103.0 ^{b*}	34.6
Freiham	Freiham	2016	N	N (RI)	13.0	78.0	27.6 ^{a*} 59.6 ^{b*}	46.3
Garching	Garching	2012	N	N (RI)	7.95	27.95	31.7 ^{a*} 42.1 ^{b*}	75.3
Grünwald/Laufzorn	Grünwald/Laufzorn	2011	Y	N (RI)	40	71	68.5 ^{a*} 285.7 ^{b*}	24.0
Holzkirchen	Holzkirchen	2017	N	N (RI)	21	na	na	na
Ismaning	Ismaning	2013	N	N (RI)	7.2	22	33.9 ^{a*} 46.7 ^{b*}	72.6

Kirchweidach	Kirchweidach	2013	N	N (RI)	max. 30.6	max. 30.6	91.6 ^{a&b*}	100.0
Landau	Landau	2011	Y	N (RI)	5	33	na	na
München Riem	München Riem	2006	N	N (RI)	13	51	66.5 ^{a*} 81.8 ^{b*}	81.3
Neustadt-Glewe	Neustadt-Glewe	1994	N	N (RI)	4	14	16.9 ^{a*} 20.8 ^{b*}	81.3
Poing	Poing	2012	N	N (RI)	8-10	38-40	34.0 ^{a*} 52.0 ^{b*}	65.4
Prenzlau	Prenzlau	1994	N	N (BHE)	0.15*	0.5*	0.4 ^{a*} 2.9 ^{b*}	13.8
Pullach	Pullach	2005	N	N (RI)	15.5	32.5	63.0 ^{a*} 67.0 ^{b*}	94.0
Sauerlach	Sauerlach	2013	Y	N (RI)	4	4	7.8 ^{a&b*}	100.0
Simbach-Braunau	Simbach-Braunau	2001	N	N (RI)	9	46.2	50.5 ^{a*}	na
Straubing	Straubing	1996	N	N (RI)	2.1	7.3	2.9 ^{a*}	na
Taufkirchen	Taufkirchen	2015	Y	N (RI)	40.0	40.0	35.0 ^{a&b*}	100.0
Traunreut	Traunreut	2015	Y	N (RI)	12.0	13.9	26.9 ^{a*} 35.8 ^{b*}	75.1
Unterföhring	Unterföhring	2009	N	Y (RI)	10	30	23.5 ^{a&b*}	100.0
Unterföhring II	Unterföhring II	2015	N	N (RI)	11.3	31.3	33.7 ^{a&b*}	100.0
Unterhaching	Unterhaching	2007	N	N (RI)	38	83	108.0 ^{a*} 144.0 ^{b*}	75.0
Unterschleißheim	Unterschleißheim	2003	N	N (RI)	7.98	23.78	42.0 ^{a*} 64.7 ^{b*}	64.9
Waldkraiburg	Waldkraiburg	2012	N	N (RI)	14	17.5	24.8 ^{a*} 25.3 ^{b*}	98.0
Waren	Waren	1984	N	N (RI)	1.3	10.742	2.4 ^{a*} 10.1 ^{b*}	23.8
total					334.5	800.6	893.3 ^{a*} 1375.5 ^{b*}	

* If 2017 numbers need to be used, please identify such numbers using an asterisk

** In case the plant applies re-injection, please indicate with (RI) in this column after Y or N.

Applications

Typically, applications are intended for heat generation. However, geothermal power plants are also used for the cogeneration of heat/cooling and electricity (see Table 7 and below example of Unterhaching).

Reduction of air pollution and GHG

By using geothermal district heating, CO₂ emissions can be saved as fossil fuels are displaced from the district heating network. For the 30 MWth geothermal district heating system in Unterhaching (see below), annual savings of around 23.4 kt CO₂ have been achieved. Between the commissioning of the plant (2007) and 2018, cumulative savings of 281 kt CO₂ were achieved. Each MW of geothermal district heating installed, thus roughly saves 0.8 kt of CO₂ in Unterhaching. These savings were calculated compared to a fuel mix for DH including natural gas. Compared to a DH system purely based on coal, CO₂ savings would be considerably higher.

The issue of local pollution from a geothermal district heating system is a second, even more important benefit compared to CO₂-reduction, because heating systems are significant sources of air pollution during the heating season.

History and market development

Suitable regions in Germany for geothermal energy are the North German Basin and North Rhine-Westphalia (see Figure 45). At present, in Germany there are 47 such plants in operation with a total power of 337 MW [1], [2]. Some 240 geothermal district heating systems are cited in the EU [8], with a total installed capacity of about 4.3 GWth, producing about 12900 GWh of thermal power. Several European countries have a long tradition in geothermal DH and set ambitious targets until 2020 for geothermal DH: Germany, France, Hungary and Italy. In Iceland, the heat demand is almost completely covered by geothermal energy. In Germany, the greater Munich area is the most prominent example of geothermal district heating nationwide (see section below).

The municipal utility Potsdam (Stadtwerke Potsdam) envisages a similar development as took place in Munich: in the course of the city action plan for climate protection, the share of natural gas in the district heating network of currently 95% is to be significantly reduced by 2030 in favour of geothermal energy. Initially, a pilot plant is planned for nine million € by 2022, with the utility investing a total of 330 million € in the district heating network.

The advantages of the technology are – apart from environmental benefits – the small area used and the reliability and low costs during operation. Disadvantages are initial high investment costs and the need for seismologic analyses and drilling.

The potential of deep geothermal energy is significant; more than 25% of the EU population lives in areas directly suitable for geothermal district heating. However, the geothermal DH technology is currently still poorly developed. Three key issues have been identified [3] to improve this situation:

- removal of regulatory barriers (such as approval procedures or concessions), and simplified procedures for operators and policy makers.
- development of innovative finance models (in addition to MAP and KfW funding) for capital-intensive geothermal DH projects.
- training of technicians and decisionmakers of regional and local authorities in order to provide the technical background necessary to approve and support projects.

Economics and business cases in Germany

Germany does not possess high-temperature geothermal resources like those in Iceland, the United States, or New

Figure 45: Regions in Germany with a high geothermal heat potential (yellow)



Source: Deutsches GeoForschungsZentrum | Wissensplattform Erde und Umwelt, CC BY 4.0

Zealand. There is no active volcanism and the country is not directly situated on an active plate boundary. However, geothermal potential does exist, which makes the situation interesting for other regions such as China.

In Germany, common deep geothermal applications for direct use are district heating plants or combined heat and power plants (CHP), thermal spas, and space heating. At present, about 180 geothermal installations of these types are in operation in Germany [4]. In 2018, the geothermal installed capacity of direct heat use applications reached 394.6 MW_{th}. The 29 district heating and combined plants accounted for the largest portion of the geothermal capacity with about 334.5 MW_{th}. Altogether, the installed capacity of deep geothermal heat use in Germany shows a considerable increase from about 160 MW_{th} in 2010 to 336.6 MW_{th} in 2015 to 394.6 MW_{th} in 2018. Heat production from deep geothermal resources rose from 716 GWh_{th} in 2010 to 1,110 GWh_{th} in 2015 to 1,377 GWh_{th} in 2017 [5].

Generating costs and selling prices are usually around 60 €/MWh thermal, with a range of 20 to 80 €/MWh_{th}. This depends on local geothermal settings (high/low heat flows, shallow/deep sources), socio-economic conditions and pricing policies (kWh_{th} or m³ of hot water) [3].

Two specific cases are described: Unterhaching in Bavaria, which already has years of experience and the city of Munich with the largest German geothermal district heating plant put into operation, as part of the city's comprehensive decarbonisation strategy.

Unterhaching

The geothermal plant of Unterhaching, south of the city of Munich was a pioneer in developing geothermal energy in combination with district heating. The plant has a thermal power of 30.4 MW [7]. Originally, the plant also produced electricity based on the Kalina process. However, in 2017 it was decided to stop the electricity generation as more and more energy was being consumed by an increasing number of thermal customers. The total investment for the geothermal plant in Unterhaching amounts to about 100 million €, of which 16 million € were needed for the Kalina plant (including maintenance in the first 10 years). The project was funded by the ZIP programme (Future Investment Programme) of the Federal Government, the Federal Ministry of Environment, the Free State of Bavaria and the KfW Renewable Energy Programme. The amortisation period is 15 years. Some technical and economic parameters are listed in Table 8, price examples for customers are given in Table 9.

Table 8: Technical and economic parameter for the geothermal plant in Unterhaching

as of August 2019 [6]

Company founded:	09/2002
Project duration:	7 years (final acceptance: 04/2009)
Investment volume:	approx. 100 million EUR (of which 16 million EUR for the Kalina plant)
Turnover:	approx. EUR 2.8 million (2008), approx. EUR 4.7 million (2009), ap-prox. EUR 7.9 million (2010), approx. EUR 7.2 million (2011), approx. EUR 3 million (2012), approx. EUR 9.0 million (2013), approx. EUR 9.5 million (2014), approx. EUR 9.4 million (2015), approx. EUR 11.4 million EUR (2016), approx. EUR 10.1 million (2017), approx. EUR 10.0 million (2018)
Number of employees:	10
Grants and loans:	among others, subsidy from the Future Investment Programme ZIP programme (Federal Government); loans for the promotion of demonstration projects: 22.4 million EUR (Federal Ministry of the Environment BMU); subsidies from the KfW Renewable Energy Programme 3.6 million EUR; loans from the KfW Renewable Energies Programme: 19, 9 million EUR
Amortization period of the investment:	approx. 15 years
Depth:	3,350 m (1st hole 2004) 3,580 m (2nd hole 2007)

Water temperature:	122°C (1st hole 2004) 133°C (2nd hole 2007)
Volume:	150 l/s (1st hole 2004) 150 l/s (2nd hole 2007)
Geothermal power:	max. 38 MW _{th}
District heating network total length:	approx. 49 km
Total connected load:	approx. 71 MW _{th}
Long-term planning:	supply from Unterhaching with 75% district heating from geothermal energy (with a connected load of approx. 90 MW)
Flow temperature:	80 - 110°C
Return temperature:	50 - 60°C
Electricity produced (Kalina system max 3.4 MW_e):	4.1 million kWh (2009-2017)
Geothermal heat produced:	9.7 million kWh _{th} (2007 - 2018)
CO2 savings:	81 kt (2007 - 2018)

Table 9: Pricing example geothermal DH in Unterhaching

As of October 2019 [8]

		Single-family house	Semi-detached buildings	Small consumer*
Consumption (kWh)		25,000	17,000	10,000
Annual cost	€; Net	2357	1879	1373
One-time connection cost (new area) **	€; Net		1578	
One-time connection cost (densified area) **	€; Net		2629	

* Small consumers: e.g. apartments with lower consumption than average. However, this can also be well-insulated single houses, the energy consumption of which is considerably lower than average.

** including heat transformer station, 5m district heat conduct on private land

City of Munich

The city of Munich is presently constructing Germany's largest geothermal CHP plant (Heizkraftwerk Süd). This is one building block in the CO₂ neutral district heating vision. By 2040, geothermal energy is to provide most of the district heating supply. The declared aim of the Municipal Supply Company of Munich (Stadtwerke München SWM): "by 2025, SWM intends to produce enough eco-power in its own power generation plants to cover Munich's entire demand. [...] By 2040, SWM will cover Munich's entire district heating demand on a CO₂-neutral basis. Tapping geothermal energy is a key element. An additional element is the expansion of green

cooling to replace individual airconditioning systems [9]."

According to SWM, district heating for more than one third of Munich's households is currently generated by cogeneration. By the year 2040, fossil fuels will be superseded by geothermal energy. In parallel, the 800-kilometre-long district heating network is being upgraded for green heating. To the south of Munich, and the adjacent southern regions, SWM – in cooperation with neighbouring communities – intends to tap additional sources of geothermal energy. The SWM

geothermal plants in Kirchstockach and Dürrnhaar will be expanded as cogeneration plants. These installations and the geothermal cogeneration plant in Sauerlach will then be linked up to Munich’s district heating network. The environs of Munich present geological preconditions that are likely to be more favorable for tapping geothermal energy than those of any other region in Germany. Hot thermal water from highly permeable limestone strata (malm) is the source of geothermal energy. At a depth of 2,000 – 3,000 metres, the water temperature ranges from 80°C to more than 100°C, which is ideal for heating purposes. The water is pumped to the surface and passes through a heat exchanger, whereby energy is extracted.

The cooled water is returned to the depths. The district heating plant is expected to reach a capacity of 50 MW and serve 80,000 customers. At present, 5 wells have been drilled with temperatures exceeding expectations. Drilling depth was 4,000 metres. By mid-2020, work on all six wells will be completed [10]. By the start of the heating season in 2020/2021, the plant will be connected to the grid.

SWM is currently operates five geothermal plants in Munich and the region. Three more plants are planned for 2025.

Ideas for pilot installations in China

China has the largest district energy system in the world, with more than 200,000 kilometres of net-works providing heat to close to 9 billion square meters of building space [11]. China possesses large geothermal energy resources, mostly in two forms [12]: First, the resources for the use of shallow geothermal energy heating (from soils, underground water, air). Second, deep geothermal energy resources from more than 1,000 metres deep. In the past few years, these two methods have been developed in China relatively fast, technology has become more mature, such as in Hebei Xiongxian, where deep geothermal resources have been utilised for district heating schemes. However, there has also been significant growth in the use of shallow geothermal energy.

According to the current development of geothermal energy planning, in the Beijing-Tianjin-Hebei region the geothermal heating area will reach 450 million square metres by 2020. This accounts for about one fifth of the amount of necessary heat in the region. Furthermore, geothermal energy has many other applications, such as providing heating for agricultural greenhouses. Geothermal energy can play a very important role in rural heating.

In 2018, the heated area in northern China supplied by geothermal energy reached nearly 260 million m2. This includes shallow geothermal and medium-deep geothermal heating, mainly distributed across Beijing, Hebei, Tianjin, Henan, Shandong, and Shaanxi. In Beijing, shallow geothermal solutions provide heating for more than 20 million m2. In Gansu, Shaanxi and other areas, medium-deep geothermal heating projects have been demonstrated. In general, geothermal heating is a mature technology.

Geothermal heating offers very safe, low-carbon and environmentally friendly heating at low operating costs. However, the initial investment is large and site selection limited by geographical conditions. Geothermal heating is hence mainly suitable for areas with good geothermal resources, cold winters with a constantly high heating demand or hot summers with a respective cooling demand. Geothermal heat can be used for heating, hot springs, and to heat greenhouses or supply domestic hot water.

According to the current regulations enacted by the Chinese government, the groundwater level must be kept constant, e.g. via the reinjection of water. Currently, some areas in Hebei and Shandong have very strict policies regarding geothermal heating in the middle and deep layers. More supportive policies have been enacted in Henan, while Shaanxi and Gansu actively promote the utilization of geothermal heating.

While China’s shallow geothermal utilization technology is relatively mature, deep geothermal technologies are still in the piloting and development stages. Depending on the geological conditions, difficulties with drilling, costs, heat transfer and piping have been reported. These issues are the major drivers for research and development for deep geothermal solutions. German companies offer both mature technologies and experiences for (deep) geothermal solutions and could partner with Chinese enterprises to further support and develop deep geothermal heating in China.

4.9 Combined heating and cooling grid with gas CHP, heat pumps and thermal storages

District heating (DH) is unevenly used across countries. District heating in Europe currently serves approximately 60 million EU citizens, with an additional 140 million living in cities with at least one DH system [2]. In Europe, the shares of DH are higher in Northern and Eastern European countries. Cooling needs are increasingly covered in combination with heating requirements. This can be achieved by installing combined heating and cooling networks.

Potential heat sources for DH are waste heat from industry, waste incineration CHP, biomass power plants, geothermal and solar thermal energy systems (central solar heating), large scale heat pumps, waste heat from cooling purposes (e.g. from data centres) and other energy sources [14]. Thus, district heating systems have considerably evolved from fossil fuels to flexible multi-energy sustainable energy sources. An important factor for enabling the integration of new (renewable) heat sources into existing heat grids – and for increasing energy efficiency, is lowering district heating networks’ temperature levels (Figure 46).

Table 10: Characterisation of district heating (DH) in countries with high shares of DH [1]

	China	Germany	Denmark	Bulgaria	Finland
Installed DH capacity (GW _m)	462.6	51.4		6.2	22.8
Length of pipelines for DH transport & distribution (1000 km)	178.1	1.4	30.8		
Share of total heated surface	55% (North China)	13.8%	64%	12%	39%

Figure 46: Evolution of district heating systems from fossil fuels to flexible multi-energy sustainable energy sources

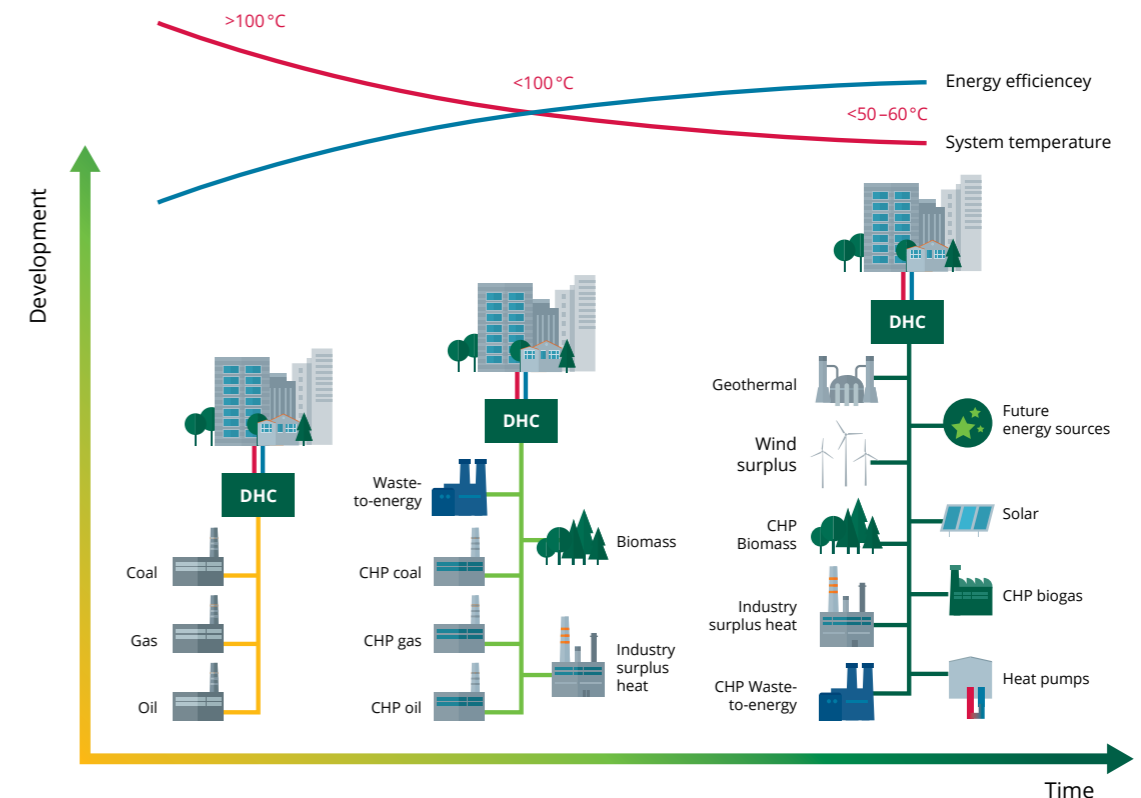

Source: Euroheat & Power

This section describes combinations of different technologies for heating/cooling purposes. It shows that fossil fuels in district heating/cooling systems can be

replaced by a combination of heat pumps, gas CHP (bio-based or natural gas), heat storage and wind or solar power (as power generators).

Application	district heating and cooling
Target group / customers	municipalities, private heating/cooling grid operators
Advantages	<ul style="list-style-type: none"> • provision of cold and heat and optimal usage of heat for cooling with electric heat pumps, • highly flexible system for integration of heat/cold market and electricity market due to heat pumps, CHP and thermal storage, • increased economic efficiency of heat pump.
Challenges	<ul style="list-style-type: none"> • additional investments for cooling grid necessary.
Costs	investment costs (Germany): 100 M€; heat generation costs (Germany): 6.5-20 ct€/kWh

Technology description

Fossil fuels (such as coal) in district heating systems can be replaced by a combination of heat pumps, heat storages, bio-based CHP and wind and solar power. Furthermore, such district heating and cooling systems support balancing an increasing share of volatile wind and solar power in the energy system (power-to-heat, i.e. overproduction of renewables is converted to heat for the DH scheme). Additionally, (bio-based) CHP plants with heat storage tanks can help to decouple power and heat generation.

For instance, during times of low wind power production (often corresponding to times of high electricity prices), bio-based CHP generate and sell electricity. However, if at the same time, the heat demand is very low, the CHP plant's excess heat can be stored in heat storages. This way, heat storages can maintain and improve the overall efficiency of the CHP plants and help integrating the variable power generation. In general, the system efficiency reaches its maximum when the entire heat is produced with either heat pumps, CHP or by utilising excess power or heat [3].

Heating grids offer the possibility to use different energy sources, including waste heat, in a large number of combinations and in a highly efficient and relatively flexible way. Thermal storages, with capacities ranging from a few hours or days to long-term storage, play an important part for integrating different heat sources. A long-term objective of European countries for DH systems is to link the heat supply with the electricity sector and, if necessary, with the transport sector to increase flexibility and decarbonise the energy supply.

Capacity, Yield and Applications

Today, heat pumps used in such heat grid applications reach capacities of 100 MW. In the future, heat pumps of up to 1000 MW could become reality according to carbon neutral approaches (i.e. a fully decarbonised large cities, see case study of Helsinki below). Examples for combined heat and cooling grids exist for small communities (see example of Dollnstein or Herten below) and large cities.

Reduction of air pollution and GHG

Such district heating networks' CO₂ reduction potentials depend on the indirect CO₂ emissions linked to the electricity used to run the heat pumps. Hence, a full decarbonisation of the power mix is necessary to achieve low-carbon heat generation. Northern European countries such as Finland, therefore aim at coupling heat pumps with wind energy. Gas CHPs used are ideally bioenergy based, and hence carbon-neutral.

History and market development

While district heating is already a rather old technology, combined heating and cooling grids with gas CHP, heat pumps and thermal storages or similar combinations are new approaches. These concepts are discussed as "fifth generation district heating and cooling systems (5GDHC)" in the literature [4]. High-temperature DH systems still suffer from significant heat losses and high installation costs. Especially in summer, when many DH systems operate only to meet the domestic hot water demand, networks' thermal losses can reach values of about 30% due to high retention times of water in the network. For these reasons, current research focuses on the fourth generation district heating (4GDH) and 5GDHC, which reach higher efficiencies by operating at lower temperatures. However, 4GDH systems are not

able to provide both heating and cooling services. This is the challenge that 5GDHC is trying to solve.

5GDHC networks are in the early stage of development. Several systems – mostly pilot projects – are in operation in Europe. Many of these systems operate differently from traditional DHC technology. For instance, they supply water to decentralised water-source heat pumps (WSHP) at temperatures between 0 °C and 30 °C. Moreover, 5GDHC permit free-floating network temperatures and the exploitation of quasi-infinite indigenous heat sources. The key added values of 5GDHC in comparison with 4GDH are:

- distribution temperatures close to ground temperature ("neutral" from thermal losses point of view),
- capability to work in heating or cooling mode independently of network temperature,
- bi-directional and decentralised energy flows.

5GDHC technology thus is part of the concept of "smart thermal grids". Such technology exploits hybrid

substations and enhances sector coupling between electrical and thermal grids in a smart energy system. The additional advantage of 5GDHC systems lies in the fact that centralised solutions can be found, in order to install seasonal heat storage in urban areas where the space availability could compromise the installation of ground heat exchangers for individual GSHPs.

The following examples describe some elements of such 5GDHC.

Economics and business cases

The economics of advanced district heating grids were analysed by IFEU (2019) [5] for different example configurations. The calculated heat costs of the example networks are between approx. 6.5 and 20.0 ct€/kWh. Comparing these costs with benchmark technologies (gas boiler/solar 8.0 to 11.0ct/kWh, pellet/solar 8.8 to 12.6 ct/kWh, heat pump 12.6 to 16.7 ct/kWh) , it becomes clear that, in comparison to the standard gas/solar system solution, network systems tend to have a high demand for subsidies, at first.

Combined heating and cooling in the municipality of Dollnstein (Germany) [6], [7]

Currently, Dollnstein's heating network supplies existing buildings such as residential buildings, the town hall, and the local school. Initially, it was planned to supply a total of 42 objects. However, as of March 2018, only 27 objects have been connected to the DHC network. The network is operated in winter as a conventional heating network with a flow temperature of 80°C. The heat is provided by a water-water heat pump (430 kW_{el}, annual efficiency: 3.3) and by a liquid-gas CHP (190 kW_{th}). If necessary, an LPG boiler (200 kW_{th}) can be switched on. In the transitional period, the flow temperature is adjusted to 70 to 75°C according to the outside temperature; if necessary, the heat supply is supported by decentral heat pumps in individual objects.

In summer, the grid is operated with a flow temperature of 25 to 30°C. The main heat generators are a solar thermal system (area of about 150 m², installed on the roof of the heating centre and a sports hall), and decentralised heat pumps. The CHP unit covers the central heat pump's power requirement and is operated according to electricity needs. A heat storage tank with a capacity of 25 m³ is used as a buffer in summer and in the transitional period. The central heat pump works with a storage system, into which the CHP's waste heat and, if necessary, solar heat is fed. The heating network is maintained by the communal company Energie Dollnstein. Commissioning took place in 2014, total investment amounted to € 1.6 million.

Figure 47: Sales price for heating/cooling in Dollnstein and components

capital cost, grid loss and generation

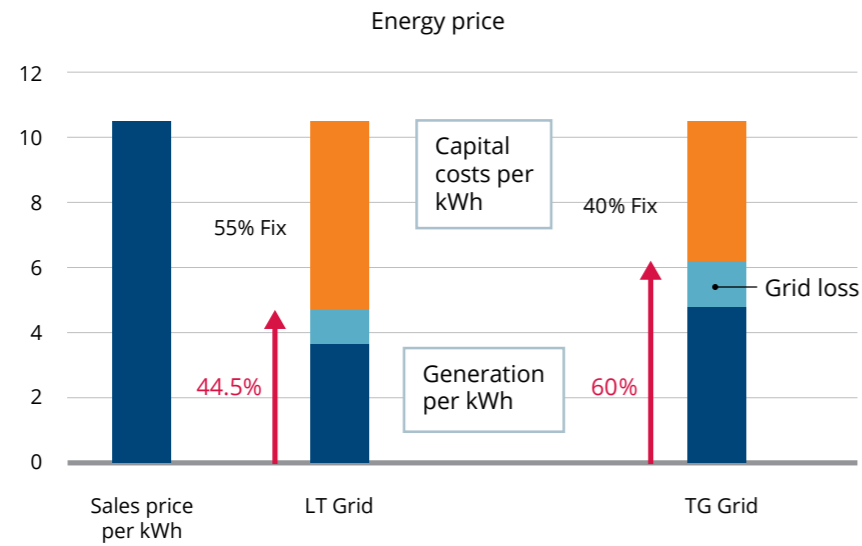

Source: [8]

Case study for using heat pumps and district heating in Herten, Germany [9]

The municipality of Herten conducted an indepth investigation and analysis of the decarbonisation potentials of its district heating network. The study analysed the technical and economic aspects of integrating various technologies such as solar thermal modules, biomass boilers, a waste incineration plant and heat pumps into the existing DH network, with the main focus on large-scale heat pumps. Herten is located in the Ruhr area in Germany. It covers an area of 37 km² with around 60,000 inhabitants and 30,000 households. The municipality's combined CO₂ emissions amounted to 419 thousand metric tonnes in 2011. Private households accounted for around 32% with space heating and domestic hot water. The total demand for heat in the residential sector in 2011 was around 470 GWh, supplied by natural gas (47%), DH (28%), heating oil (16%), coal (5%) and electricity (4%).

The DH grid of Herten is currently supplied by coal-fired CHP, which is typical for many German cities. The low price of coal-based DH supply is a major challenge for alternative supply options. The study showed that by adjusting the influencing parameters, a heat pump-based DH supply system could be designed with the same heat supply costs as the current coal-fired DH system. Five major levers were identified [9]:

- Increasing the heating network's capacity factor from 0.2 to 0.75 (equivalent to increasing the annual running hours from 1950h to 6550h) greatly decreases the heat supply costs.
- Reducing the average supply temperature from 80 to 60°C substantially reduces the heat supply costs. However, while this option is straightforward for new DH systems, this would involve retrofit-ting of the DH system and probably incurs additional costs.
- Lowering the electricity price by removing levies related to the renewable feed-in tariff significantly decreases heat costs.
- Further (but less pronounced) reduction of heat supply costs can be achieved by reducing the heat pump's capital expenditure (CAPEX) (either by grants or technical learning) and by operating the heat pump based on hourly spot market electricity prices, thereby providing flexibility to the electricity grid.
- However, even after all the above options are implemented, a CO₂ price for the coal-fired heat supply of at least 20 €/t CO₂ would still be needed to reach cost parity.

Table 11: Overview of options for the possible future district heating system of Herten

Scenario	Decentralised supply	Thermal renovation	DH expansion	DH supply
1. RES for decentralised supply/no renovation	Continuous transition to RES supply and efficient fossil fuel boilers	No renovation (same demand as in 2014)	No expansion (same size as in 2014)	No replacement (2014 supply with coal CHP)
2. Thermal renovation		With renovation (52% demand reduction until 2050 compared to 2014)		With replacement (ST)
3. Ren. + Solar thermal in DH				With replacement (HP)
4. Ren. + Heat pumps in DH			With expansion	With replacement (ST + HP)
5. Ren. + RES DH expansion			No expansion (2014 size)	With replacement (more waste incineration heat)
6. Ren. + Waste incin. in DH			With expansion	With replacement (ST + HP + waste incineration heat)
7. Ren. + Roadmap				

Source: [15]

District heating and cooling system Helsinki

In Helsinki, Finland's capital, energy utility Helen Ltd. operates a CHP-based district heating and cooling system (Figure 48). Helsinki's heat demand is to 90% covered by energy-efficient district heating. The length of the district heating network is over 1,350 km, expanding by 15-20 km annually [10]. Table 12 shows the main parameters of the system today and possible layouts with a view towards a 100% fossil fuel free scenario for the city in the future.

The basis for the combined district heating and cooling (CHC) is the simultaneous demand for heating and cooling needs and existing surplus energy. Office buildings require cooling during the warm season (Helsinki's connected cooling capacity is approximately 200 MW), while neighbouring apartment buildings need hot water (and space heating) throughout the year. Further, commercial objects, such as office buildings, shopping centres or data centres, generate surplus heat that can be utilised for heat production instead of condensing it into the air.

In winter, Helsinki is heated with high-efficiency CHP power plants. In summer, solar waste heat is collected with a district cooling network, transformed and used for heating hot water. All year round, the CHC system collects the excess heat from data centres and purified waste water to use the heat where it is needed. The renewable district heat produced with district cooling is returned to the properties connected to the district heating and cooling system for utilisation.

The new CHC-based district cooling production consists of a combined heat pump plant of five heat pumps, added to the production infrastructure in late 2006, and ten absorption units. The total heat pump cooling capacity of the system is 60 MW. The plant's heating capacity is 90 MW. A policy measure which gives a strong push to this development is that the Finnish parliament recently approved a government proposal to ban the use of coal for energy production from 1 May 2029 [11].

Figure 48: Combined Heat and Power (CHP)-based district heating/cooling (DHC) Helsinki

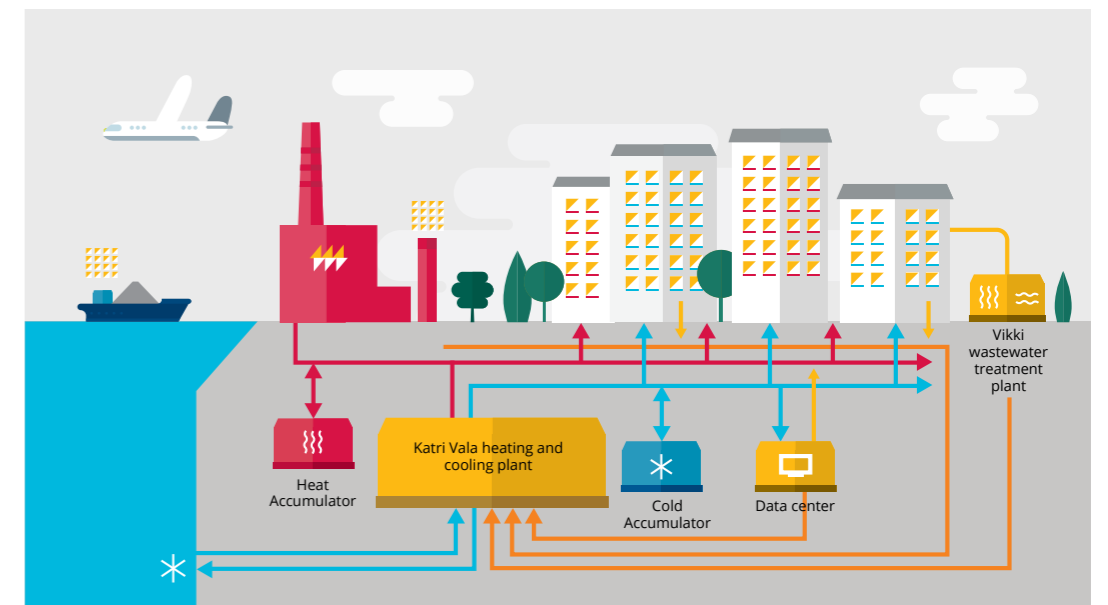

Source: [12]

Table 12: Installed heat production capacity by Helen Ltd. in 2017 and in a 100% fossil-free scenario for the City of Helsinki

Energy production capacity	Installed heat capacity by Helen Oy, 2017	Installed heat capacity and energy sources used in Helsinki in 100% fossil fuel-free scenario
Heat pumps	100 MW	1,100 MW, using ambient and waste heat and mostly wind power
CHP, district heating	1300 MW	300 MW (+200 MW power), using biomass
Heat only boilers used for peak heat demand	2000 MW	1,100 MW, using liquid fuels or synthetic gas made from clean electricity (wind, solar, nuclear) or biomass
Electric boilers used to convert peaks of excess electricity to heat		200 MW, using mostly wind power
Heat storages	0.002 TWh	0.015 -0.03 TWh - with upcoming heat storage of 0.014 TWh in Mustikkamaa33 the system can already work well

Source: [8]

In future scenarios, the fossil fuels used for producing district heating in Helsinki could be mostly replaced with heat pumps (1,100 MW), which would amount to about ten times the present power plant's capacity. Some of the heat pumps would be located in machinery halls, office buildings, shopping centres, schools, businesses and housing companies. In order to produce the electricity consumed by these heat pumps, about 170 wind turbines would be required (700 MW). These could be built in areas with ideal wind conditions such as Ostrobothnia or Lapland.

Alongside heat pumps and wind power, heat storage technologies are necessary to even the volatile power generation from wind and solar power. In cold climates, heat storage is a significantly cheaper option than electricity storage. In fact, when heat storage is included in district heating networks, the costs can be as low as 1% of those of electricity storage. Electricity storage and demand response in residential buildings are suitable solutions for power supply variations lasting from a few seconds to several hours. Heat storage, on the other hand, can be used to store energy for days, weeks or even months.

Weekly heat storages would provide sufficient flexibility for Helsinki as periods of low wind power production normally only last a few days. Periods of insufficient wind power can be dealt with in district heating networks in a cost-efficient way through the use of heat storages and flexible, bio-fuel based CHP. The system can shift between different energy sources depending on electricity market prices. When it is very windy and electricity is cheap, the heat pumps can use wind power and the heat storages can be filled up. When it is not windy and electricity is expensive, the heat pumps empty the heat storages and bio-CHP plants are switched on.

Ideas for pilot installations in China

China has the largest district energy system in the world, with more than 200,000 kilometres of networks providing heat to close to 9 billion square metres of building space [13]. However, a large part of these district heating networks is operated with fossil fuels. For the existing networks it makes sense to transition to 5th generation district heating networks with feed from regenerative sources. However, it should be noted that the building stock must also meet appropriate standards in order to lower the temperatures in the district heating networks. By using 5th generation district heating networks, however, primary energy and greenhouse gases can be avoided

5GDHC systems are suitable for large energy-consuming areas requiring both cooling and heating. 5GDHC is therefore applicable for buildings requiring high energy supply safety, such as hospitals, hotels, commercial complexes, high-end office buildings, transport hubs, data centres, factories or public buildings. Furthermore, such facilities offer a stable power and heating (cooling) demand resulting in higher economic efficiency. Intelligent cascade utilisation with GSHPs, water source heat pumps, thermal storages and renewable storage could contribute to the future development

of 5GHDCs in combination with distributed solutions. In China, 5GHDC systems could be applied to economically developed urban areas such as the Jing-Jin-Ji Region, the Yangtze River and Pearl River Deltas.

In Beijing, a first pilot project featuring the combined supply of natural gas, cooling, heating and power has already been implemented. In this project, two sets of gas-fired internal combustion engines (total capacity of 1,205 kW) are used to supply electricity. Their waste heat is utilised for providing hot and cold water to heating and air-conditioning systems. Peak demand is covered by the direct burning of natural gas. The building is not connected to the public power grid. Due to the building's low-energy demand, CHP units are often operated at low load and low efficiency. Another project, Beijing Xiedao Power-Heating-Cooling Integrated Energy Center operates four sets of gas internal combustion engines (total capacity of 3 MW) in combination with water heat pumps, heat and ice storage, and solar thermal systems to supply electricity, heat, refrigeration, and domestic hot water. The Shenyang Dongyu Building uses a power, heating and cooling integrated energy system based on biomass. Throughout the combustion of biomass in a biomass boiler, steam is generated to drive a steam turbine. After power generation the steam exhausted is used for heating and cooling. Pilot projects should demonstrate and focus on the integrated utilisation of different energy types and formulate energy utilisation strategies according to demand while improving the system energy efficiency.

4.10 Industrial excess heat recovery

Industrial excess heat is generated by many industrial processes using process heat. From a technical point of view, excess heat can be described as unwanted heat generated by an industrial process [1]. From a social point of view, it can be described as heat which is a by-product of industrial processes and currently not utilised, but which could in future be used by society and industry [2]. This excess heat can be used to feed district heating and cooling networks. Alternatively, the heat can be transported via heat containers by truck or rail [3]. Industrial waste heat can be used either within a single

process itself, within the plant or across companies. For the use of industrial excess heat, the temperature level of the excess heat is decisive. A distinction is made between high temperatures, medium temperatures and low temperatures [4]. Excess heat from high and medium temperature ranges (>150°C) can in most cases be used process-internally or to generate electricity [5]. Low temperature excess heat, however, cannot be used for such purposes. Therefore, low temperature excess heat offers the best possibility for feeding district heating and cooling networks.

Application	use of industrial excess heat for space heating or cooling and domestic hot water supply or cooling in residential and non-residential buildings.
Target group / customers	residential and non-residential buildings in urban areas near district heating networks within proximity to industry.
Advantages	<ul style="list-style-type: none"> usage of (unwanted) industrial excess heat, proven technology, reduction of GHG-emissions.
Challenges	<ul style="list-style-type: none"> additional (partly capital-intensive) infrastructure is needed, contractual regulation between industrial operator and operator of the district heating network, avoidance of negative effects on the production process.
Costs	2-5 ct€/kWh _{th}
Specific CO2 factor	0 g/kWh

Figure 49: Excess heat utilisation technologies

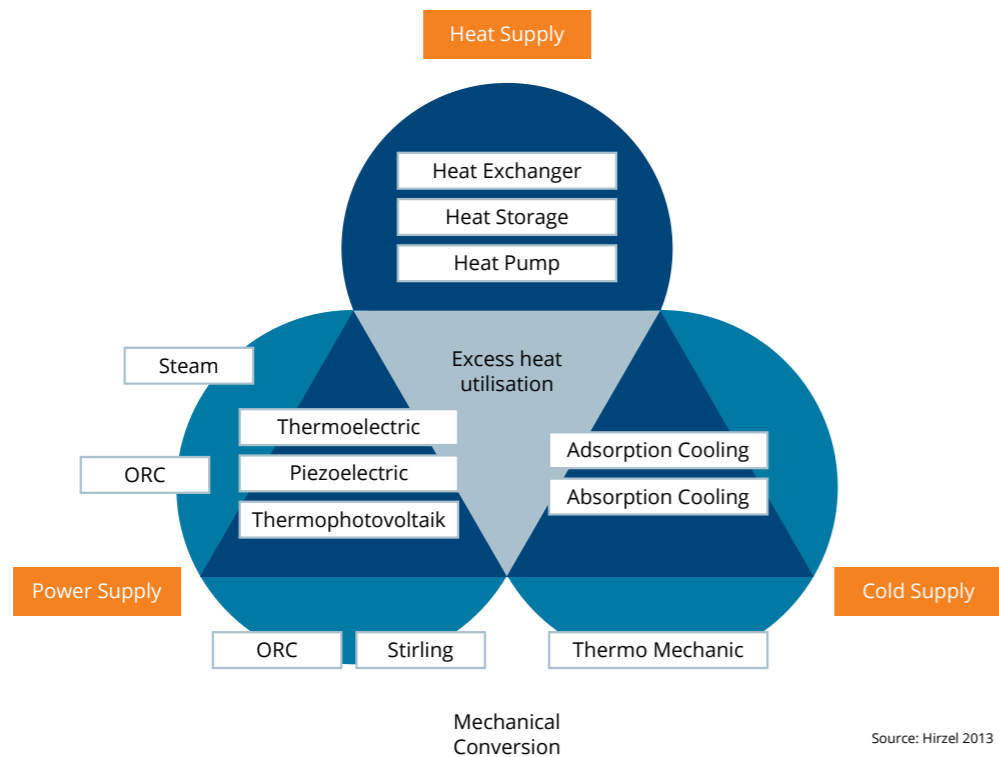
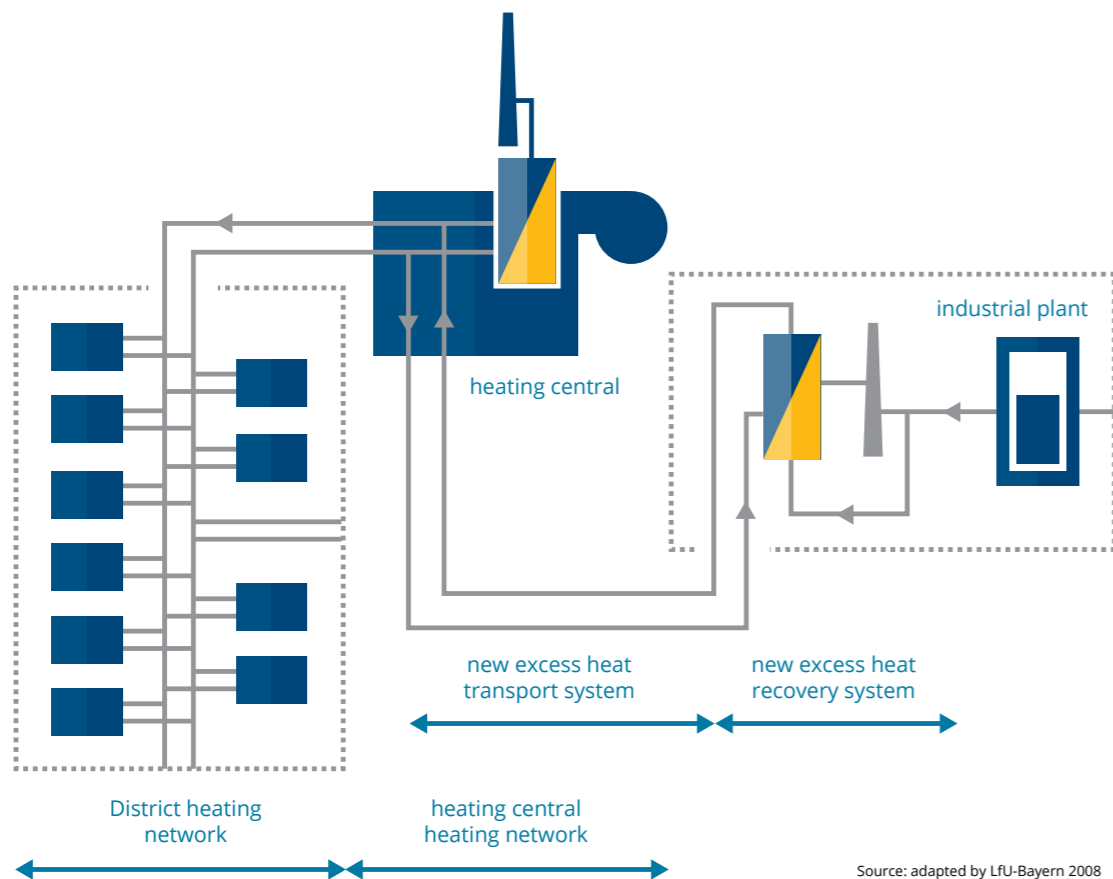

Figure 50: Schematic representation of excess heat recovery



Technology description

Technologies for the use of industrial excess heat

Figure 49 shows the different possibilities of utilising indirect excess heat. The excess heat can either be used to generate electricity, to provide mechanical energy or to provide heating and cooling. Heat exchangers, heat storages and heat pumps are mainly used for the thermal utilisation of industrial excess heat. The excess heat can be recovered from exhaust gas, exhaust air, cooling water or waste water [6] and then fed into district heating networks. Figure 50 shows a schematic representation of excess heat recovery from exhaust gas. Heat exchangers form the basic component of an excess heat recovery system. They transfer the existing excess heat to a colder medium and thus make it usable. Heat storages offer the possibility of a temporal flexibilisation. The same amount of excess heat is continuously available in most industrial plants. However, the demand for heat in residential and non-residential buildings fluctuates both during the day and in the course of the year. Heat pumps are responsible for increasing the existing excess heat’s temperature level. This is necessary in particular if the existing excess heat has a lower temperature level than the temperature in the connected district heating network.

Capacity and yield

The heat capacity depends on the amount of available excess heat, the temperature level of the excess heat and the distance to the location of the heating demand. The possible heat generation capacity therefore depends on many influencing factors and must be determined for each individual case.

[5] investigates the potential of excess heat utilisation in German district heating networks and reports a total technical potential of 23–29 TWh_{th}/a. Taking into account the economic efficiency of the networks, the total potential for Germany amounts to 19–21 TWh_{th}/a. In comparison, the total amount of heat fed into German district heating networks in 2017 was approx. 85 TWh. Hence, industrial excess heat could supply approx. 25% of Germany’s current district heating demand.

Applications

Industrial excess heat should be used within the company or process in which it is generated. If this is not possible – due to low temperatures or a lack of demand for heat, excess heat can be used for space heating and domestic hot water supply. In order to use the industrial excess heat in buildings, the energy must be transported via district heating networks or heat containers. This is suitable in areas with large industrial plants and a high heat demand.

Important combinations with other technologies

When installing systems for the utilization of excess heat, it is important to avoid corrosion of sensitive systems [5]. In some cases an additional flue gas cleaning is necessary. Alternatively, heat exchangers and other installations can be made of corrosion-resistant material.

If the temperature levels of existing excess heat sources lie below the district heating network’s requirements, their temperature level must be raised. Due to this, the use of heat pumps is necessary in many applications. ([1] & [8])

In some installations, it is recommended to install backup devices to secure the operation [9]. This means that on the one hand cooling facilities are still available in industrial plants and on the other hand backup facilities are available in district heating networks. In addition, it should be possible to decouple the individual systems so that they can run independently.

Reduction of air pollution and GHG

In the assessment of industrial excess heat utilisation, CO₂ emissions depend above all on the definition of system limits. If it is assumed that the heat is available as a free resource, there are no additional emissions of GHG or pollutants from the usage of industrial excess heat. Therefore, the systems contribute significantly to local reductions. But if it is assumed that the use of industrial excess heat displaces other heat producing facilities that could supply district heating, a positive effect is not always discernible. This largely depends on the current electricity mix. If, for example, a CHP plant is pushed out of operation, the remaining power plants must cover the electricity generated by the CHP plant. This may even lead to GHG emissions rising compared to CHP plants [10].

History and market development

Technologies for excess heat recovery were already known in the 19th century. In the 20th century, several technological leaps made the use of excess heat possible. It was only between 1960 and 1970 that industrial excess heat was fed into district heating networks, due to the expansion of urban areas and the construction of new complex buildings. However, the general expansion of district heating networks in Germany was much slower than in Scandinavia and Eastern Europe. In the 1980s and 1990s, the issue of excess heat utilisation was given greater consideration, as great progress was made in CHP technology [11].

In Germany, the “Guideline for the Promotion of Excess Heat Avoidance and Excess Heat Utilisation in Commercial Enterprises” got into effect in 2016.. This directive offers financial incentives to companies for investments open to all types of technology in the avoidance and use of excess heat. Support for companies is granted in the form of a repayment subsidy for loans that are refinanced by KfW. Such support is granted for new buildings, building extensions, plant modernisation and connecting pipes to avoid and use excess heat.

Funding is granted for the internal avoidance of excess heat, the external use of excess heat, the generation of electricity from excess heat and the preparation, implementation and monitoring of excess heat concepts. In 2016 and 2017, a total of 179 cases were funded in Germany. This led to an annual CO2 saving of 123,500 tonnes and an annual final energy saving of 4,80,000 MWh. [12] Furthermore, Germany promotes heating networks via additional laws and subsidy schemes such as Combined Heat and Power Act [5].

Figure 51: District heating rail Rhein-Ruhr

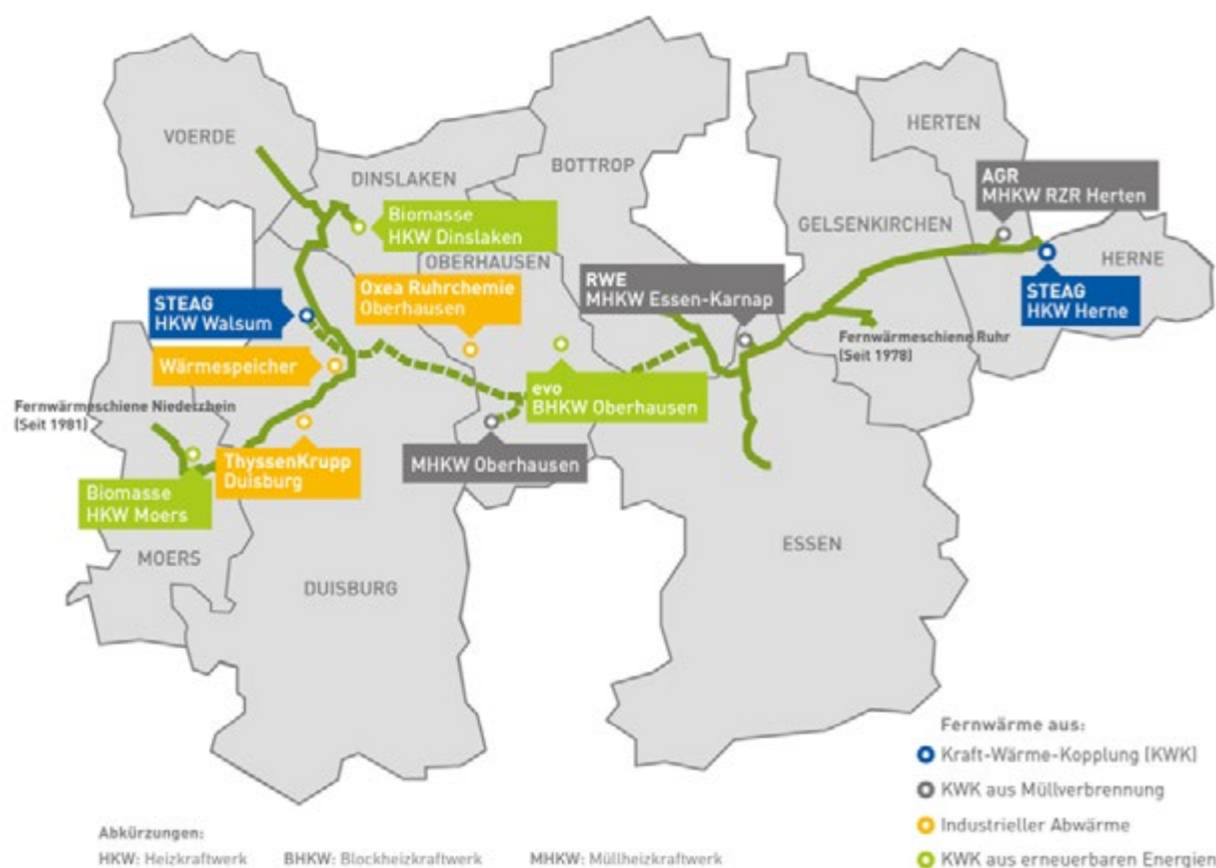

This figure depicts the “district heating rail Rhein-Ruhr” in the German federal state of North Rhine Westphalia. The district heating rail connects local heating networks with industrial heat sources and CHP plants across a large area and was realised in 2009. It supplies more than 400.000 buildings with heat. The total heat demand of all buildings amounts to 1.8 GWh. Annual GHG savings of 100.000 t/a are realised. The CO₂ avoidance costs are less than 50€/t_{CO2}. The average heat price (without subsidies) in the year 2010 was 7.49 ct€/kWh. [15]

Economics and business cases in Germany

In Karlsruhe (Baden-Wuerttemberg), the industrial excess heat from the mineral oil refinery Oberrhein has been fed into the city’s district heating network since 2010. Hence, up to 43,000 households are supplied with

district heating. The project had a total investment volume of 54 million €. The annual GHG savings amount to 100.000 t/a. The heat price without subsidies in the year 2019 was 6.08 ct€/kWh.

Figure 52: Heat exchangers at an industrial facility in Karlsruhe



It is difficult to derive a general statement regarding the economic viability of industrial excess heat utilisation for space heating. This is only possible to a limited extent due to individual districts’ different framework conditions.

The investment costs are composed of specific investments for the heat exchangers and additional piping. These are specified in [6] with 70-450€/kW of excess heat capacity. Depending on the application, the investment costs for heat pumps and heat accumulators may also be added. Results from [5] show that the heat production costs in most operations amount to 20-50€/MWhth. If the heat must be raised to a higher temperature level, these costs increase accordingly due to the employment of a heat pump.

The explicit evaluation of a specific project always requires the consideration of the individual circumstances. The economic viability depends on the economic viability of the excess heat utilisation and the local district heating network, thus:

- The feasibility highly depends on the available excess heat supply and on its distance from the heat demand [13],
- The higher the available amount of excess heat is, the lower the specific installation costs [5],
- The higher the heat demand density is, the lower the installation costs of the local heating network [16],
- The higher the heat demand density, the lower the network losses [14].

Ideas for pilot installations in China

China has the largest district energy system in the world, with more than 200 000 kilometres of networks providing heat to close to 9 billion square metres of building space [17]. For this reason, it can be very useful to feed industrial waste heat into the existing heating networks. This allows fossil fuels to be displaced from the heating networks and thus saves primary energy and greenhouse gas emissions.

China has abundant industrial waste heat resources. Estimates show that the industrial waste heat resources are 3.5 times larger than China’s total heat demand. North China’s large heat demand could hence be covered by environmentally friendly industrial waste heat recovery. However, waste heat resources are scattered, intermittent and instable. More than 50% of industrial waste heat is of medium and low quality (i.e. low temperature). The main waste heat sources stem from metallurgy, chemical industry, building materials, glass, pulp and paper, textile and machinery industry. While high quality steam is already sufficiently utilised and recovered within industry processes, the utilisation of medium and low-quality waste heat should still be improved. In northern China, industrial waste heat recovery could meet the requirements of supplying safe, stable and continuous heating. Environmental regulations, i.e. air pollution limits, forcing factories operating in industries which cause a lot of pollution to shut down production under high-pollution conditions, pose a challenge for the supply safety of industrial waste heating.

In general, existing industrial waste heat recovery systems combine absorption heat pumps and electrical heat pumps. Due to the heat pumps’ high COP, a large amount of heat can be recovered at low operating costs. Pilot projects should further evaluate economics of industrial waste recovery systems (including factors such as suitable distances between heat sources and load centres and heat load intensity), focus on increasing the overall energy efficiency of production processes and evaluate the effects of forced production stops on heat supply.

5 Discussion and conclusion

This report describes ten selected sustainable heating solutions – suitable for different applications and framework conditions – and analyses their application potential in China. Future heating systems will certainly not rely solely on these ten solutions, but on a large variety of technology combinations. Among the decentralised heating technologies, air source heat pumps are currently the most widely used solution in China. Pilot applications exist for the combination of ground source and air source heat pumps with PV. While decentralised biomass shows a great potential due to onsite utilisation of biomass fuels and low operating costs, China still lacks relevant (environmental) standards. All district heating technologies presented, including sewage source heat pumps, deep geothermal heating, industrial waste heat recovery, bioenergy villages and innovative cogeneration systems, have a wide application potential. To further support their utilisation, the respective solutions should be chosen depending on a combination of resources, climatic conditions and techno-economic factors. For all of these, German experiences provide good reference and demonstration cases for China. From an economic perspective, particularly the operating costs and sustainability aspects are the most important selection criteria. Many of the technologies listed are currently still more expensive than conventional heating solutions. Political and financial support measures are therefore necessary to further promote their development.

Figure 53 characterises the ten selected sustainable heat solutions according to the following five criteria:

- Greenhouse gas reduction potential:** All selected solutions have a significant GHG reduction potential, making them interesting for the time horizon 2030 and 2050. Nevertheless, differences occur where substantial amounts of electricity are involved for auxiliary aggregates, e.g. for the running of heat pumps or of fluid circulation pumps etc. Here, the electricity mix has a major impact on the performance. Given the present power mixes in Germany and China with high shares of coal-based generation, the GHG advantage of some of these technologies is still limited. With the upcoming phase-out in Germany and the further increased

share of renewable energies in the power mix, however, the entire GHG reduction potential of these technologies could be exploited/realised.

- Local pollutant reduction potentials:** most of the sustainable heating solutions listed show a very good local pollutant reduction potential. However, this is only partly the case for solutions relying on biomass. For example, particle and NOx emissions are highly dependent on user behaviour. For most of the other technologies no local emissions occur. However, especially for those solutions requiring a steady power input, their life-cycle emissions depend on the (local) power mix. Local pollutant reduction potentials are hence similar to GHG emission reduction potentials (s. above) and depend on both local emissions as well as pollutants reduction measures in local power plants.
- Resources:** Under resources we group issues such as the non-sustainable use of abiotic or biotic resources including water (ground and surface water) and land area. The various technologies present a rather mixed picture. Biomass in particular is a limited and contested resource as other sectors (i.e., transport and industry) strive to increase their biomass shares in their energy consumption. For other technologies (e.g. solar thermal collector fields) land use is an issue. Geothermal ground water utilisation could be limited by seismic risks.
- Total costs:** total costs, expressed in LCOH (levelised cost of heating), are partly higher than for standard heat generation technologies (up to 30–50% higher). It is important to underline, however, that the absolute costs cannot directly be compared between China and Germany. A cost analysis should be refined in more detailed studies for the Chinese context. In addition, future cost degression will most likely further lower unit costs on a global level.
- Market diffusion:** half of the technologies listed are already in some stage of market diffusion (e.g. reduced emission biomass) while others, such as the more complex combinations of PVT and heat pumps are still in their infancy or in an intermediate stage (solar thermal collector fields or deep geothermal). However, all the technologies listed attract an increasing market demand. Future cost degression might even further spur their development.

Cross-cutting characterisation of the ten selected sustainable heat technologies

Figure 53: Cross-cutting characterisation of the ten selected sustainable heat technologies (green: very positive – orange: challenges to be considered)

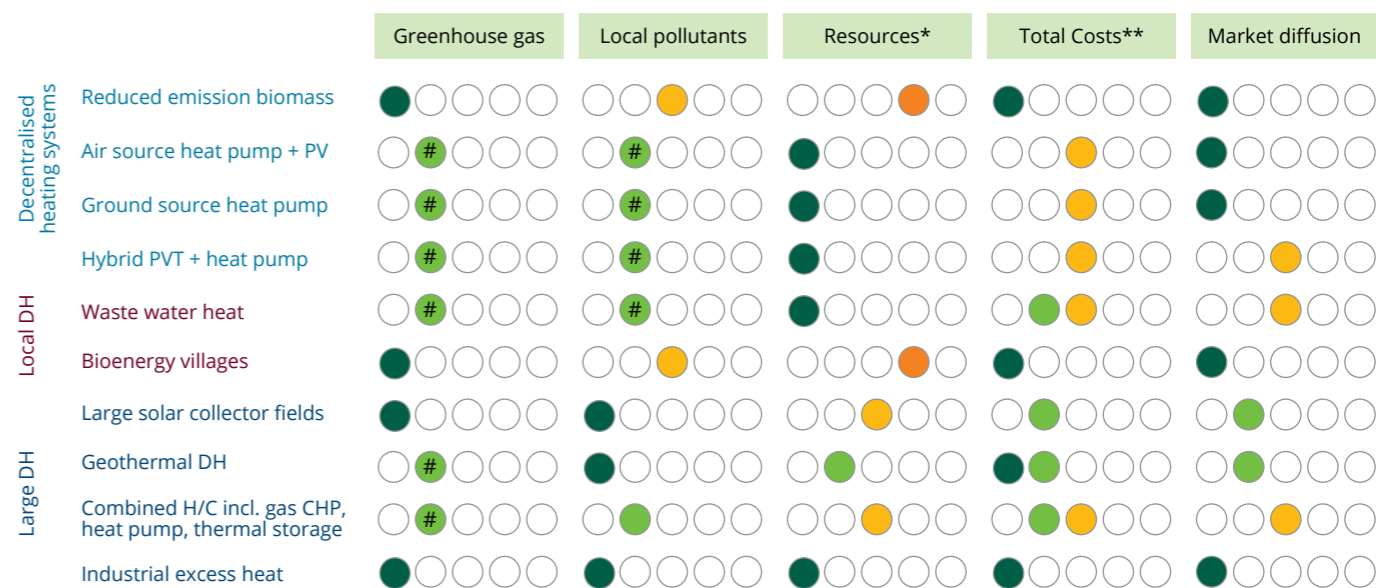

Notes:
 * non-sustainable use of abiotic or biotic resources incl. water and surface area
 ** LCOH (levelised cost of heat), compared to standard heat generation technology
 # depending on electricity mix

There are a number of trends and policy instruments which will strongly impact and spur the demand for sustainable heating solutions. Apart from decarbonisation and pollutant emission reduction, these include (see Figure 54):

- Hybridisation of technologies (particularly combinations with heat pumps or thermal storage);
- Sector coupling (i.e. the heat sector providing flexibility to the power sector, which is increasingly important due to high shares of variable renewable

energy sources) and shifting towards the fifth generation of district heating systems offers large potentials for innovative heating solutions;

- Low exergy (i.e. shifting towards lower temperatures in heating systems and distribution);
- Finally, digitalisation and automation open new avenues for sustainable heating technologies, which contribute to both local pollution and GHG reductions. In the medium-term, a full decarbonisation of the power sector will further enhance these potentials.

Figure 54: Trends impacting the future of the selected sustainable heat technologies

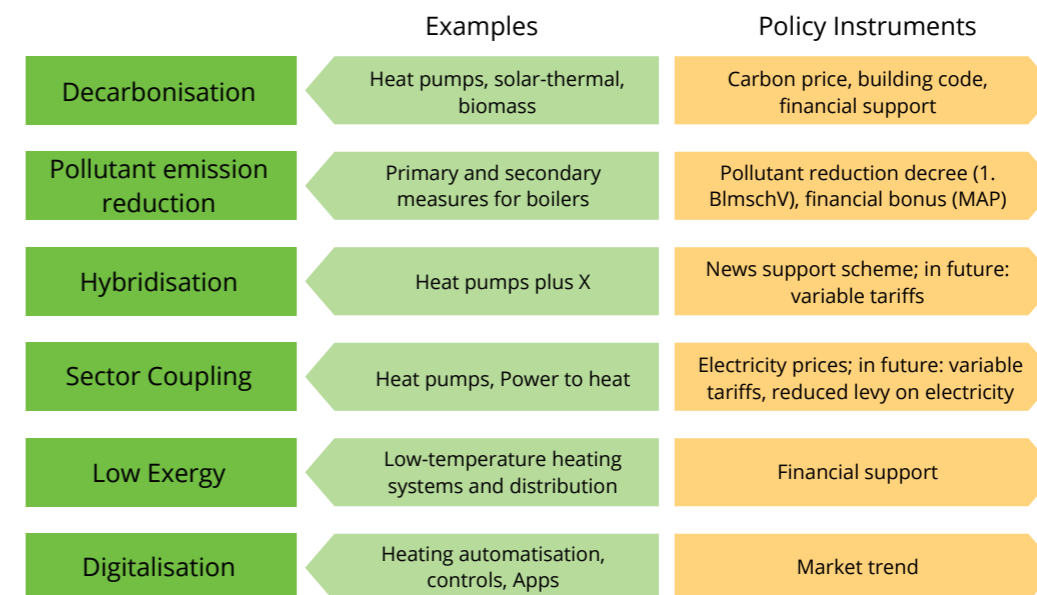

Source: own illustration

6 List of figures

Figure 1: Final energy consumption by end-uses in Germany 2017	9
Figure 2: Final energy demand by building type and building category	9
Figure 3: Final energy demand for heating by energy carrier in 2018	10
Figure 4: GHG emissions of buildings and targets in Germany until 2050	10
Figure 5: Main federal policy instruments supporting sustainable heating in Germany up to 2019	11
Figure 6: Air and exhaust gas flow in a twin-fire oven with optimised particle emissions	15
Figure 7: Filters for wood and other solid fuel stoves can be placed in the chimney or integrated into the stove	15
Figure 8: Particle reduced stove in a private home	16
Figure 9: Retrofit of an existing biomass stove	17
Figure 10: Principles of electric driven compression heat pump	18
Figure 11: COP as a function of ambient temperature for different supply temperatures	21
Figure 12: Specific investment costs of air source heat pumps in Germany	22
Figure 13: Volunteer fire station in Lachendorf	23
Figure 14: Multi-family house in Rösrath	23
Figure 15: Roth logistics centre	24
Figure 16: COP as a function of ambient temperature for different supply temperatures for GSHP	27
Figure 17: Specific investments of GSHP in Germany	29
Figure 18: Old pumping station Haan – heat pump with ice storage in a reutilised non-residential building	29
Figure 19: Headquarters of Freiberg Instruments Ltd. – space heating and space cooling for an office building	30
Figure 20: East wing of Geneva airport – large geothermal heat pumps for airport terminal	30
Figure 21: Useful energy for heating and electricity from solar irradiance and schematic depiction of PVT collector and heat pump	32
Figure 22: Classification of PVT collectors	33
Figure 23: Storing excess heat from PV in geothermal probes	34
Figure 24: Sewage canal heat exchanger (left) and bypass heat exchanger (right)	36
Figure 25: Principle of a waste water heat recovery system	36
Figure 26: Concept for heating and cooling at IKEA Lichtenberg in Hamburg	37
Figure 27: Sewage canal heat exchanger in Bretten	38
Figure 28: Sewage canal heat exchanger in NeckarPark	38
Figure 29: Material flows in a bioenergy village	41
Figure 30: Installed thermal capacities (kW) of wood chip boilers in 80 bioenergy villages	42
Figure 31: Combination of biomass plants with other renewable energy technologies	42
Figure 32: Specific GHG emissions of different heat supply technologies	43
Figure 33: Bioenergy village Büssigen	43
Figure 34: Bioenergy village Randegg	44
Figure 35: Specific investment costs of automatically stoked biomass-fired boilers, fully assembled, including ash removal, air and flue gas system, and flue gas cleaning	44

Figure 36: Spatial distribution (100*100 m) of net crop residues in China in 2009	45
Figure 37: The principle of a gravel pit seasonal storage	47
Figure 38: ETC collectors in the field in Büsingen	48
Figure 39: Installed large solar thermal fields in Germany as of August 2019	48
Figure 40: FPC collectors in the field near Dronninglund	48
Figure 41: Investment cost break down in a specific solar thermal collector field in Dronninglund (total cost: 14.6 million €)	49
Figure 42: ETC collectors in a field near Senftenberg	49
Figure 43: Different types of geothermal energy usage	52
Figure 44: Deep geothermal plant in Munich	53
Figure 45: Regions in Germany with a high geothermal heat potential (yellow)	55
Figure 46: Evolution of district heating systems from fossil fuels to flexible multi-energy sustainable energy sources	59
Figure 47: Sales price for heating/cooling in Dollnstein and components	62
Figure 48: Combined Heat and Power (CHP)-based district heating/cooling (DHC) Helsinki	63
Figure 49: Excess heat utilisation technologies	66
Figure 50: Schematic representation of excess heat recovery	66
Figure 51: District heating rail Rhein-Ruhr 82	68
Figure 52: Heat exchangers at an industrial facility in Karlsruhe	79
Figure 53: Cross-cutting characterisation of the ten selected sustainable heat technologies (green: very positive – orange: challenges to be considered)	71
Figure 54: Trends impacting the future of the selected sustainable heat technologies	71

7 List of tables

Table 1: Decentralised sustainable heating systems	12
Table 2: Local district heat (DH)	13
Table 3: Large district heating (transformation)	13
Table 4: Different system components of air source heat pumps	20
Table 5: Specific investments of air source heat pump with PV and a DHW electric heater	23
Table 6: Different system components of ground source heat pumps	26
Table 7: Existing geothermal district heating (DH) plants in Germany, individual sites [4]	53
Table 8: Technical and economic parameter for the geothermal plant in Unterhaching	56
Table 9: Pricing example geothermal DH in Unterhaching	57
Table 10: Characterisation of district heating (DH) in countries with high shares of DH [1]	59
Table 11: Overview of options for the possible future district heating system of Herten	63
Table 12: Installed heat production capacity by Helen Ltd. in 2017 and in a 100% fossil-free scenario for the City of Helsinki	64

8 List of abbreviations

Abbreviation	Details
5GDHC	Fifth Generation of District Heat
BlmschV	Federal Ordinance on Pollution Control (Germany)
CHP	Combined Heat and Power
COP	Coefficient of Performance
DH	District Heat
DHW	Domestic Hot Water
ETC	Evacuated tubular collector
FPC	Flat plate collector
GeoDH	Geothermal District Heating
GHG	Greenhouse Gas
GSHP	Ground Source Heat Pump
LCOH	Levelized Cost of Heat
MAP	Market incentive programme (for renewables in Germany)
NOx	Nitrogen Oxides
OM Cost	Operating and Maintenance Cost
PV	Photovoltaics
PVT	Photovoltaic-thermal collector
RES	Renewable Energy Sources
RES-H	Renewable Energy Sources for Heating
tce	Tonnes of coal equivalent (1 tce = 29.39 gigajoules)

9 Bibliography

Chapter 2.2 Heating/cooling demand and policies in Germany

- [1] Federal Ministry of Economics and Technology, Energiedaten - nationale und internationale Entwicklung, (2019). <http://www.bmwi.de/DE/Themen/Energie/Energiedaten/gesamtausgabe.html> (accessed November 16, 2019).
- [2] H. Cischinsky, N. Diefenbach, M. Rodenfels, Datenerhebung Wohngebäudebestand 2016. Anleitung zur Durchführung von Auswertungen mit der Auswertungsdatenbank, 2018.
- [3] J. Steinbach, D. Staniaszek, F. Anagnostopoulos, R. Lottes, L. Kranzl, A. Toleikyte, Die Sanierung des deutschen Gebäudebestandes - eine wirtschaftliche Bewertung aus Investorensicht, in: Energieeffizienz Gebäuden - Jahrb. 2016, VME - Verlag und Medienservice Energie Jürgen Pöschk, Berlin, 2016: pp. 77–86.
- [4] C. Sebi, S. Nadel, B. Schломann, J. Steinbach, Policy strategies for achieving large long-term savings from retrofitting existing buildings, 2015 (2018).
- [5] Bürger, V., Klimaneutraler Gebäudebestand 2050: Herausforderungen an Politik und Infrastrukturentwicklung. Presentation on the BAFA Energietag 2019, 1.10.2019. Öko-Institut Freiburg.

Chapter 4.1 Small solid biomass stoves with heavily reduced particle emissions

- [1] BMWI: Federal Ministry for Economic Affairs and Energy, Energiedaten - nationale und internationale Entwicklung, (2019). <http://www.bmwi.de/DE/Themen/Energie/Energiedaten/gesamtausgabe.html> (accessed November 16, 2019)
- [2] Struschka, M., J. Goy, A. Gugelfuß (2017): Methodische Bewertung von Sekundärmaßnahmen für kleine Biomassefeuerungen(mit Messberichten zu den Teilprojekten I bis III und Kurzbericht zu ergänzenden Messungen IV. Institut für Feuerungs- und Kraftwerkstechnik (IFK), Universität Stuttgart. Download http://fachdokumente.lubw.baden-wuerttemberg.de/servlet/is/125865/U40-U84-N05-IFK-Bericht_mit_Anhaengen_07032018.pdf?command=downloadContent&filename=U40-U84-N05-IFK-Bericht_mit_Anhaengen_07032018.pdf
- [3] Fichtner et al. (2016): Evaluierung von Einzelmaßnahmen zur Nutzung erneuerbarer Energien im Wärmemarkt (Marktanreizprogramm) für den Zeitraum 2012 bis 2014, Fichtner, TFZ, Universität Kassel et al. Report commissioned by the Federal Ministry for Economic Affairs and Energy. Stuttgart
- [4] XEOOS, <https://www.xeoos.de/technik.html>

Chapter 4.2 Air source heat pump system in combination with PV module and DHW heater

- [1] Volker Quaschnig: Erneuerbare Energien und Klimaschutz. Hintergründe, Techniken, Anlagenplanung, Wirtschaftlichkeit 2008.
- [2] Details. URL: <https://www.waermepumpe.de/presse/pressemitteilungen/details/bwp-marktzahlen-2018-nachhaltiges-wachstum-mit-luft-nach-oben-deutliches-signal-fuer-die-politik/#content>. Abrufdatum 19.09.2019.
- [3] Kosten einer Wärmepumpe (Preisvergleich). URL: <https://www.energieheld.de/heizung/waermepumpe/kosten>. Abrufdatum 24.09.2019.
- [4] Bundesverband Wärmepumpe (BWP). BWP-Datenbank - .Freiwillige Feuerwehr La-chendorf. URL: https://www.waermepumpe.de/presse/referenzobjekte/bwp-daten-bank/?tx_refobjdb_house%5Bdetailid%5D=106&tx_refobjdb_house%5Baction%5D=show&tx_refobjdb_house%5Bcontroller%5D=House#content. Abrufdatum 25.09.2019.
- [5] Bundesverband Wärmepumpe (BWP). BWP-Datenbank - MFH Rösath. URL: https://www.waermepumpe.de/presse/referenzobjekte/bwp-daten-bank/?tx_refobjdb_house%5Bdetailid%5D=28&tx_refobjdb_house%5Baction%5D=show&tx_refobjdb_house%5Bcontroller%5D=House#content. Abrufdatum 26.09.2019.
- [6] Bundesverband Wärmepumpe (BWP). BWP-Datenbank - Roth Logistikzentrum. URL: https://www.waermepumpe.de/presse/referenzobjekte/bwp-daten-bank/?tx_refobjdb_house%5Bdetailid%5D=85&tx_refobjdb_house%5Baction%5D=show&tx_refobjdb_house%5Bcontroller%5D=House#content. Abrufdatum 25.09.2019.
- [7] BMWi (2015). Richtlinien zur Förderung von Maßnahmen zur Nutzung erneuerbarer Energien im Wärmemarkt vom 11. März 2015. https://www.erneuerbare-energien.de/EE/Redaktion/DE/Downloads/Foerderbekanntmachungen/marktanreizprogramm-erneuerbare-energien.pdf?__blob=publicationFile&v=13
- [8] Energy Agency North Rhine Westfalia. Combination of heat pumps and photovoltaics (2015) [EnergieAgentur.NRW. Leitfaden Wärmepumpen – Kombination von Wärmepumpen und Photovoltaik.

Chapter 4.3 Ground source heat pump system

- [1] Volker Quaschnig: Erneuerbare Energien und Klimaschutz. Hintergründe, Techniken, Anlagenplanung, Wirtschaftlichkeit 2008.
- [2] Bundesverband Wärmepumpe (BWP). Absatzzahlen für Heizungs- und Warmwasser-Wärmepumpen. 2018. <https://www.waermepumpe.de/presse/pressemitteilungen/details/bwp-marktzahlen-2018-nachhaltiges-wachstum-mit-luft-nach-oben-deutliches-signal-fuer-die-politik/#content>. Abrufdatum 19.09.2019.

- [3] Kosten einer Wärmepumpe (Preisvergleich). URL: <https://www.energieheld.de/heizung/waermepumpe/kosten>. Abrufdatum 24.09.2019.
- [4] Bundesverband Wärmepumpe (BWP). BWP-Datenbank - Alte Pumpstation. URL: https://www.waermepumpe.de/presse/referenzobjekte/bwp-datenbank/?tx_refobjdb_house%5Bdetailid%5D=60&tx_refobjdb_house%5Baction%5D=show&tx_refobjdb_house%5Bcontroller%5D=House#content. Abrufdatum 26.09.2019.
- [5] Bundesverband Wärmepumpe (BWP). BWP-Datenbank-Firmenzentrale Freiberg Instruments GmbH. URL: https://www.waermepumpe.de/presse/referenzobjekte/bwp-datenbank/?tx_refobjdb_house%5Bdetailid%5D=109&tx_refobjdb_house%5Baction%5D=show&tx_refobjdb_house%5Bcontroller%5D=House#content. Abrufdatum 26.09.2019.
- [6] Bundesverband Wärmepumpe (BWP). BWP-Datenbank- Östflügel Genfer Flughafen. URL: https://www.waermepumpe.de/presse/referenzobjekte/bwp-datenbank/?tx_refobjdb_house%5Bdetailid%5D=108&tx_refobjdb_house%5Baction%5D=show&tx_refobjdb_house%5Bcontroller%5D=House#content. Abrufdatum 26.09.2019.
- [7] BMWi (2015). Richtlinien zur Förderung von Maßnahmen zur Nutzung erneuerbarer Energien im Wärmemarkt vom 11. März 2015. https://www.erneuerbare-energien.de/EE/Redaktion/DE/Downloads/Foerderbekanntmachungen/marktanreizprogramm-erneuerbare-energien.pdf?__blob=publicationFile&v=13
- [8] Bundesverband Wärmepumpe (BWP). Absatzzahlen für Heizungs- und Warmwasser-Wärmepumpen. 2018. <https://www.waermepumpe.de/presse/pressemitteilungen/details/bwp-marktzahlen-2018-nachhaltiges-wachstum-mit-luft-nach-oben-deutliches-signal-fuer-die-politik/#content>. Abrufdatum 19.09.2019.
- [9] OCHSNER Wärmepumpen: <https://www.ochsner.com/de-de/ochsner-produkte/waermepumpen-fuer-grosse-leistungen/>
- [10] VIESSMANN: <https://www.viessmann.de/de/gewerbe/waermepumpe/grosswaermepumpen/waermepumpen-bis-2-mw.html>

Chapter 4.4 Hybrid photovoltaic-thermal collector in combination with heat pump

- [1] Federal Ministry for Economic Affairs and Energy, Energiedaten - nationale und internationale Entwicklung, (2019). <http://www.bmwi.de/DE/Themen/Energie/Energiedaten/gesamtausgabe.html> (accessed November 16, 2019).
- [2] H. Cischinsky, N. Diefenbach, M. Rodenfels, Datenerhebung Wohngebäudebestand 2016. Anleitung zur Durchführung von Auswertungen mit der Auswertungsdatenbank, 2018.
- [3] J. Steinbach, D. Staniaszek, F. Anagnostopoulos, R. Lottes, L. Kranzl, A. Toleikyte, Die Sanierung des deutschen Gebäudebestandes - eine wirtschaftliche Bewertung aus Investorensicht, in: Energieeffizienz Gebäuden - Jahrb. 2016, VME - Verlag und Medienservice Energie Jürgen Pöschk, Berlin, 2016: pp. 77-86.
- [4] C. Sebi, S. Nadel, B. Schломann, J. Steinbach, Policy strategies for achieving large long-term savings from retrofitting existing buildings, 2015 (2018).
- [5] BDH, Efficient systems and renewable energies, Federal Industrial Association of Germany, House, Energy and Environmental Technology, 2013.
- [6] DIN V 18599-5, Energy efficiency of buildings - Calculation of the net, final and primary energy demand for heating, cooling, ventilation, domestic hot water and lighting - Part 5: Final energy demand of heating systems, Dtsch. Inst. Für Normung (Hrsg.); Beuth Verlag, Berlin. (2011).
- [7] DESTATIS, Official statistic on buildings and flats [Fachserie 5 Reihe 3 - Gebäude und Wohnungen], Statistical Office Germany [Statistisches Bundesamt Deutschland], Wiesbaden, 2019.
- [8] A. Stuible, D. Zech, H.-F. Wülbeck, E. Sperber, M. Nast, H. Hartmann, K. Reisinger, C. Budig, J. Orozaliev, F. Pag, K. Vajen, R. Erler, S. Janczik, M. Kaltschmitt, M. Niederberger, Evaluierung von Einzelmaßnahmen zur Nutzung erneuerbarer Energien im Wärmemarkt (Marktanreizprogramm) für den Zeitraum 2012 bis 2014. Evaluierung des Förderjahres 2014, 2016.
- [9] Fraunhofer ISE, Photovoltaics Report, 2019.
- [10] S. Portal, Kosten von Photovoltaikanlagen in 2019, Solaranlagen Portal. (2019). <https://www.solaranlagen-portal.de/photovoltaik/preis-solar-kosten.html#!> (accessed October 20, 2019).
- [11] B. Sanner, Ground Source Heat Pumps – history , development , current status , and future prospects, in: 12th IEA Heat Pump Conf., Rotterdam, The Netherlands, 2017.
- [12] M. Lämmle, THERMAL MANAGEMENT OF PVT COLLECTORS - Development and modelling of highly efficient glazed, flat plate PVT collectors with low-emissivity coatings and overheating protection, Fraunhofer Institut für Solare Energiesysteme (ISE), 2018.
- [13] U. Leibfried, A. Wagner, A. Abdul-zahra, SOLINK – PVT-Energieversorgungssystem für Wärmepumpen, Karlsruhe, Lörrach, 2017.
- [14] Consolar, SOLINK – Der Wärmepumpenkollektor Energiequelle für Wärmepumpen, 2017. https://www.consolar.de/produkte/kollektorenmodule/waermepumpenkollektor_solink.html.
- [15] Consolar, PVT-Kollektor SOLINK, Consolar Solare Energiesysteme. (2018). https://www.consolar.de/produkte/kollektorenmodule/waermepumpenkollektor_solink.html (accessed November 3, 2019).
- [16] BMWi, BMU, The German government's Energy Concept - Long-term strategy for future energy supply, Berlin, 2010. http://www.bmu.de/english/energy_efficiency/doc/46516.php (accessed December 4, 2012).

- [17] Kesselheld, Hybridkollektoren: Arten, Vorteile, Funktionen & Kosten - Kesselheld, 2019. (n.d.). <https://www.kesselheld.de/hybridkollektoren/> (accessed November 3, 2019).
- [18] BINE, Solardächer doppelt nutzen - Hybrid-Kollektoren auf dem Dach liefern Strom, 2012. <http://www.bine.info/publikationen/publikation/solardaecher-doppelt-nutzen/>.

Chapter 4.5 Waste water heat recovery

- [1] AGFW | Effizienzverband für Wärme, Kälte und KWK e.V. (2017) Fernwärme - Preisübersicht (Stichtag: 01.10.2017).
- [2] Buri, R., und Kobel, B. (2004). Wärmenutzung aus Abwasser - Leitfaden für Inhaber, Betreiber und Planer von Abwasserreinigungsanlagen und Kanalisation. Leitfaden für Inhaber, Betreiber und Planer von Abwasserreinigungsanlagen und Kanalisationen. Bern.
- [3] Butz, J. A., und Müller, E. A. (2010). Abwasserwärmenutzung – Erfahrungsbericht über Planung und Bau der Anlage in Bretten. Korrespondenz Abwasser, Abfall, 57(8), 765-770.
- [4] Kasag (2019): Utilization of waste water heat in the sewage canal, sewer, canalisation; Online available via: <https://www.kasag.com/en/renewable-energies-systems-plants-heat-exchanger-heat-from-wastewater/>; last Access: 17.09.2019
- [5] Christ, O., und Mitsdoerffer, R. (2008). Regenerative Energie nutzen - Wärmequelle Abwasser. WWT - Wasserwirtschaft Wassertechnik (05/2008): M6 - M12.
- [6] DWA 2009: Brune, P. et al.: (2009). Energie aus Abwasser - Wärme- und Lageenergie. Merkblatt DWA-M 114 - DWA Regelwerk. Hennef.
- [7] DBU 2005: Energie aus Abwasser - Leitfaden für Ingenieure und Planer. (2005). Bern/Osnabrück.
- [8] Uhrig (2019): References UHRIG Energy from waste water, Therm-Liner, state: 15.01.2019; Online available via: <https://www.uhrig-bau.eu/en/energy-from-wastewater/references-information/>; Last Access: 17.09.2019
- [9] Schitkowsky (2010): Wärmerückgewinnung aus Abwasser, Präsentation. Online available via: http://www.abwasserbilanz.de/wp-content/uploads/101213_schitkowsky.pdf; Last Access: 17.09.2019
- [10] Görres, J. (2015). Abwasserwärmenutzung. Präsentation Energiewendebauen, Online available via: https://projektinfos.energiewendebauen.de/fileadmin/user_upload/Neuigkeiten/2015/20150520_MeetingAachen/08_Goerres_Abwasserwaermenutzung_Stuttgart.pdf; Last Access: 17.09.2019
- [11] Christ, O., et al. (2010). Potenzial aus dem Kanal. Wärme aus Abwasser, IFAT 2010 SPECIAL
- [12] ifeu 2019: Fritz, S. and Pehnt, M. (2018): Kommunale Abwässer als Potenzial für die Wärmewende? Study on behalf of the Federal Ministry for the Environment, Nature Conservation and Nuclear Safety
- [13] FFE 2017: Einflüsse der Temperaturspreizung in Nahwärmenetzen. (2017), Forschungsstelle für Energiewirtschaft e.V. Retrieved July 17, 2018 from <https://www.ffe.de/die-themen/speicher-und-netze/184-einfluesse-der-temperaturspreizung-in->; Last Access: 17.09.2019
- [14] badenova 2007: Hagspiel, B. (2007). Wärme aus Abwasser - Evaluation von Technik, Betrieb und Randbedingungen Potenzial der Kanalwärmenutzung in Freiburg im Breisgau. Freiburg im Breisgau.
- [15] Uhrig (2018): Wärmewende mit Energie aus Abwasser – Das unterschätzte Potential im Kanal; Online available via: https://www.thega.de/fileadmin/thega/pdf/thega-forum/2018/vortraege/session1/stephan_von_bothmer_uhrig_therm-liner_waermewende_mit_energie_aus_abwasser.pdf; Last Access: 17.09.2019
- [16] IKK Energetische Stadtsanierung – Quartiersversorgung (201) - [https://www.kfw.de/inlandsfoerderung/C3%96ffentliche-Einrichtungen/Energetische-Stadtsanierung/Finanzierungsangebote/Energieeffiziente-Quartiersversorgung-Kommunen-\(201\)/](https://www.kfw.de/inlandsfoerderung/C3%96ffentliche-Einrichtungen/Energetische-Stadtsanierung/Finanzierungsangebote/Energieeffiziente-Quartiersversorgung-Kommunen-(201)/)
- [17] Uhrig 2017: von Bothmer, C., und von Bothmer, S. (2017). Energie aus Abwasser: Turbo für die Wärmewende, Helmut UHRIG Straßen- und Tiefbau GmbH
- [18] Müller, E., Schmid, F., Kobel, B. (2005): Heizen und Kühlen mit Abwasser: Ratgeber für Bauträger und Kommunen; Deutsche Bundesstiftung Umwelt

Chapter 4.6 Bioenergy villages/communities

- [1] C.A.R.M.E.N.: Website <https://www.carmen-ev.de/biogene-festbrennstoffe/biomasseheizwerke/wirtschaftlichkeit/474-waermegestehungskosten> (accessed on 05.11.2019)
- [2] Bioenergy communities in Germany: Website: <https://bioenergiesdorf.fnr.de/index.php?id=2116> (accessed on 05.11.2019)
- [3] Statista Website: <https://www.statista.com/statistics/278566/urban-and-rural-population-of-china/> (accessed on 05.11.2019)
- [4] Ruppert, H., Eigner-Thiel, S., Girschner, W., Karpenstein-Machan, M., Roland, F., Ruwisch, V., Sauer, B. & Schmuck, P. (2008). Wege zum Bioenergiesdorf. Leitfaden. Gülzow: Fachagentur Nachsende Rohstoffe.
- [5] Roland, F., Eigner-Thiel, S. (2016). 10 Jahre Bioenergiesdörfer-Ergebnisse einer Metaanalyse von 160 Bioenergiesdörfern und die Betrachtung von sozialen Aspekten bei der Umsetzung im Juni 2015
- [6] Fachagentur Nachwachsende Rohstoffe e.V. (2019). Bioenergy in Germany, Facts and figures 2019

- [7] Jiang, D., Zhuang, D., Fu, J., Huang, Y., Wen, K. (2012). Bioenergy potential from crop residues in China: Availability and distribution. *Renewable and Sustainable Energy Reviews* 16

Chapter 4.7 Large solar collector fields

- [1] Pehnt, M., Nast, M., et al. (2017): Wärmenetzsysteme 4.0. Kurzstudie zur Umsetzung der Maßnahme „Modellvorhaben erneuerbare Energien in hocheffizienten Niedertemperaturwärmenetzen. Report commissioned by the Federal Ministry for Economic Affairs and Energy. Ifeu – Institut für Energie- und Umweltforschung Heidelberg, adelphi consult, PwC, Ecofys Germany. Download <https://www.ifeu.de/wp-content/uploads/W%C3%A4rmenetze-4.0-Endbericht-final.pdf>.
- [2] Sandrock, M., T. Pauschinger (2019): Versorger und Stadtwerke entdecken die Solarthermie, ehp Magazin, 10/2019.

Chapter 4.8 Geothermal district heating

- [1] Sonnenseite: ökologische Kommunikation mit Franz Alt: <https://www.sonnenseite.com/de/energie/muenchen-baut-deutschlands-groesstes-geothermie-kraftwerk.html>
- [2] ITG Informationsportal Tiefe Geothermie: <https://www.tiefegeothermie.de/>
- [3] GEODH Geothermal District Heating: <http://geodh.eu/database/>
- [4] European Geothermal Congress 2019: Den Haag, The Netherlands, 11-14 June 2019: <http://europeangeothermalcongress.eu/wp-content/uploads/2019/07/CUR-12-Germany.pdf>
- [5] GeotIS 2019: (Geothermal Information System for Germany): Data on geothermal direct use and electricity, (2019), <http://www.geotis.de>.
- [6] Geothermie Unterhaching: https://www.geothermie-unterhaching.de/cms/geothermie/web.nsf/id/pa_daten_fakten.html
- [7] ITG Informationsportal Tiefe Geothermie: <https://www.tiefegeothermie.de/projekte/unterhaching>
- [8] Geothermie Unterhaching: [https://www.geothermie-unterhaching.de/cms/geothermie/web.nsf/gfx/6DE739FA51FA3FCFC125847F0046D42C/\\$file/Preisbeispiel%20Preisblatt%202019.pdf](https://www.geothermie-unterhaching.de/cms/geothermie/web.nsf/gfx/6DE739FA51FA3FCFC125847F0046D42C/$file/Preisbeispiel%20Preisblatt%202019.pdf)
- [9] SWM Stadtwerke München: <https://www.swm.de/english/company/renewable-energies.html>
- [10] Think Geoenergy: <http://www.thinkgeoenergy.com/fifth-well-successfully-drilled-for-munichs-geothermal-district-heating-network/>
- [11] IEA International Energy Agency: <https://www.iea.org/publications/freepublications/publication/DistrictEnergySystemsInChina.pdf>
- [12] Think Geoenergy: <http://www.thinkgeoenergy.com/china-highlighting-the-tremendous-role-of-geothermal-heating-for-the-country/>
- [13] https://www.upgrade-dh.eu/images/Publications%20and%20Reports/D2.5_2019-07-02_Upgrade-DH_Handbook_EN.pdf

Chapter 4.9 Combined heating and cooling grid with Gas CHP, heat pumps and thermal storages

- [1] Euroheat, Country Profiles 2017 (<http://www.euroheat.org/knowledge-hub/country-profiles/>)
- [2] Euroheat & Power 2018: Top District Heating Countries – Euroheat & Power 2015 Survey Analysis. - <https://www.euroheat.org/news/district-energy-in-the-news/top-district-heating-countries-euroheat-power-2015-survey-analysis/>
- [3] Smart Energy Transition: http://smartenergytransition.fi/wp-content/uploads/2018/11/Clean-DHC-discussion-paper_SET_2018.pdf
- [4] 5th generation district heating and cooling systems. A review of existing cases in Europe (2019). In: *Renewable and Sustainable Energy Reviews* 104, S. 504–522. Online verfügbar unter <https://www.sciencedirect.com/science/article/pii/S1364032118308608/pdf?md5=fcc350261d0d1867058b714caca1c7e9&pid=1-s2.0-S1364032118308608-main.pdf>.
- [5] ifeu 2017: <https://www.ifeu.de/wp-content/uploads/W%C3%A4rmenetze-4.0-Endbericht-final.pdf>
- [6] tft 2015: https://www.tftgmbh.de/fileadmin/user_upload/Wissen/PR_Text_Dollnstein.pdf
- [7] C.A.R.M.E.N.: <https://www.carmen-ev.de/biogene-festbrennstoffe/waermenetze/1966-waermenetze-neu-gedacht>
- [8] euroheat: <https://www.euroheat.org/wp-content/uploads/2016/04/Case-study-Helsinki-GDECA15.pdf>
- [9] euroheat: <https://www.euroheat.org/knowledge-hub/role-costs-large-scale-heat-pumps-decarbonising-existing-district-heating-networks/>
- [10] smart energy transition: http://smartenergytransition.fi/wp-content/uploads/2018/11/Clean-DHC-discussion-paper_SET_2018.pdf
- [11] Reuters: <https://uk.reuters.com/article/finland-energy-coal/finland-approves-ban-on-coal-for-energy-use-from-2029-idUKL5N20N6QV>
- [12] Euroheat: <https://www.euroheat.org/wp-content/uploads/2016/04/Case-study-Helsinki-GDECA15.pdf>
- [13] International Energy Agency: <https://www.iea.org/publications/freepublications/publication/DistrictEnergySystemsInChina.pdf>
- [14] https://www.upgrade-dh.eu/images/Publications%2520and%2520Reports/D2.5_2019-07-02_Upgrade-DH_Handbook_EN.pdf
- [15] Popovski, Eftim et al (2019): The role and costs of large-scale heat pumps in decarbonising existing district heating networks – A

case study for the city of Herten in Germany. In: *Energy* 180, S. 918–933. DOI: 10.1016/j.energy.2019.05.122.

Chapter 4.10 Industrial excess heat recovery (ISI)

- [1] Pehnt 2010: Energieeffizienz. Ein Lehr- und Handbuch: Springer-Verlag.
- [2] Viklund 2014: Technologies for utilization of industrial excess heat. Potentials for energy recovery and CO2 emission reduction. In: *Energy Conversion and Management* 77, S. 369–379.
- [3] Pehnt 2010: Die Nutzung industrieller Abwärme – technisch-wirtschaftliche Potenziale und energiepolitische Umsetzung, Bericht im Rahmen des Vorhabens „Wissenschaftliche Begleitforschung zu übergreifenden technischen, ökologischen, ökonomischen und strategischen Aspekten des nationalen Teils der Klimaschutzinitiative“ https://www.ifeu.de/wp-content/uploads/Nutzung_industrieller_Abwaerme.pdf
- [4] Schaefer 1995: Energiewirtschaftliche Bedeutung der Nutzung von Abfallenergie. In: Fratzscher, W.; Stephan, K. (Hrsg.): *Abfallenergienutzung. Technische, wirtschaftliche und soziale Aspekte. Interdisziplinäre Arbeitsgruppe Optionen zukünftiger industrieller Produktionssysteme.* Berlin: Akademie, S. 42–60.
- [5] Bloemer 2019: EnEff:Wärme -netzgebundene Nutzung industrieller Abwärme (NENIA), Kombinierte räumlich-zeitliche Modellierung von Wärmebedarf und Abwärmeangebot in Deutschland, Schlussbericht im Auftrag des Bundesministeriums für Wirtschaft und Energie
- [6] LfU-Bayern 2008: Leitfaden zur Abwärmenutzung in Kommunen. Augsburg. Online: https://www.gfm-ingenieure.de/fileadmin/Daten/Aktuelles/leitfaden_abwaermenutzung.pdf
- [7] Hirzel 2013: Industrielle Abwärmenutzung, Kurzstudie im Rahmen des Begleitforschungsprojekts Effizienzfabrik - Innovationsplattform Ressourceneffizienz in der Produktion https://www.effizienzfabrik.de/ecomaXL/files/Kurzstudie_Abwaermenutzung.pdf&download=1
- [8] Popovski 2018: Technical and economic feasibility of sustainable heating and cooling supply options in southern European municipalities-A case study for Matosinhos, Portugal. *Energy*, 153, 311-323.
- [9] Rink 2013: Nutzung industrieller Abwärme durch die Stadtwerke Karlsruhe zur Wärmeversorgung der Stadt Karlsruhe, Investitionen zur Verminderung von Umweltbelastungen Programm des Bundesministeriums für Umwelt, Naturschutz und Reaktorsicherheit, Abschlussbericht 70441 – 1/13 https://www.umweltinnovationsprogramm.de/sites/default/files/2019-09/1514-stadtwer-ke_karls-ruhe_gmbh.pdf
- [9] Fritz 2019: Don't waste the water, use wastewater - excess heat distribution for private households through sewer networks, European Council for an Energy-Efficient Economy -ECEEE-, Stockholm: eceee Summer Study 2019. Proceedings
- [10] Ivner 2015: Effect of the use of industrial excess heat in district heating on greenhouse gas emissions: A systems perspective. *Resources, Conservation and Recycling*, 100, 81-87.
- [11] Bergmeier 2013: The history of waste energy recovery in Germany since 1920. *Energy*, 28(13), 1359-1374.
- [12] Hirzel 2019: Evaluierung und Weiterentwicklung des Energieeffizienzfonds (Projekt Nr. 63/15) im Auftrag des Bundesministeriums für Wirtschaft und Energie (BMWi)
- [13] Doračić 2018: Evaluation of Excess Heat Utilization in District Heating Systems by Implementing Levelized Cost of Excess Heat. *Energies*, 11(3), 575.
- [14] FFE 2019: Einflüsse der Temperaturspreizung in Nahwärmenetzen. (2017), Forschungsstelle für Energiewirtschaft e.V. Retrieved July 17, 2018 from <https://www.ffe.de/die-themen/speicher-und-netze/184-einfluesse-der-temperaturspreizung-in->
- [15] FWSRR 2019 <https://www.fwsrr.de/home/>
- [16] AGFW | Effizienzverband für Wärme, Kälte und KWK e.V. (2017) Fernwärme - Preisübersicht (Stichtag: 01.10.2017).
- [17] International Energy Agency 2017: <https://www.iea.org/publications/freepublications/publication/DistrictEnergySystemsInChina.pdf>

A.1 Long List of Sustainable Heating Strategies

Nb	Technology Name	Heat source	Supply Temperature [°C]	Capacity range [kWthermal]	Main application	Typical heated surface area [m ²]	Further technical data	Level of diffusion in German market [1: only single application, 5: widely applied]	Air pollution	Contribution GHG reduction	Cost attractiveness [1: high heat generatio costs due to investment or fuel cost, ... 5: low heat costs = very attractive]	Strengths and Weaknesses	Further remarks	Suggestion
Decentralized heating														
1	Low emission log-wood stove	Biomass log wood	All typical domestic heating systems	Typical: 3-15	Rural residential buildings to replace bulk coal or natural gas. Urban buildings as secondary heating	20-200 (also for partial heating)		5	Low direct emissions • either due to electronic control and ignition or due to secondary combustion	High • Biomass is GHG neutral when harvested from sustainable forestry	5	• Needs log wood. • Cheap and efficient combustion. • With special heat exchangers, stoves can be turned into heating systems.		applicable for China
2	Air source heat pump system in combination with PV module and DHW heater	Ambient heat/ electricity	70 Optimal efficiency below 40	Typical: 2.5-20 Available: <= 100 kW	Residential buildings (<250 m ²). Best suited for well insulated houses with floor heating. --> Combination of heat pump and insulation!	typ. <250, larger available	Seasonal performance factor: 3.5 (optimal heat supply temperature)	5	No direct emissions • since locally only electricity from PV or from the grid is used.	Medium-high • Dependent on size of local PV-modules and emissions of central power production. In any case less emissions than from direct electric heating.	3	• Lower investments than for ground source heat pumps. • Applicable for heating and cooling • Efficiency is highly dependent on outside ambient temperature and heat supply temperature in the building • Low efficiency during cold days. Resulting in high demand for electric power.	35.000 air to water heat pumps are sold per year Suitable for integration with Solar-PV	applicable for China
3	Ground source heat pump	Geothermal heat/ electricity	70 Optimal efficiency below 40	Typical: 6-34 Available: <= 100 kW	Residential buildings (<250 m ²). Best suited for well insulated houses with floor heating. --> Combi of heat pump and insulation!	typ. <250, larger available	Seasonal performance factor: 4.5 (optimal heat supply temperature)	5	No direct emissions • as electricity and environmental heat are used as fuel and heat source. Indirect emissions depends on the power generation mix.	Medium-high • The effect depends on power generation. Compared to fossil-fired heating, CO ₂ savings up to 63% can be achieved (German Energy mix).	2	• Lower energy costs than Air HP. • Applicable for heating and cooling. • Efficient heat generation only with low supply temperatures • Works with underfloor, wall or low-temperature radiator	Suitable for integration with Solar-PV	applicable for China
4	Fuel cell Micro CHP with peak load gas boiler	Natural gas / (future: Methane produced from Hydrogen and RES electricity)	All typical domestic heating systems	Fuel cell: 0.7 kWel/ 1.1 kWel Peak load boiler: 10 - 30 kWth	Residential buildings (<400 m ²)	typ. <250, larger available		2	Low direct emissions	Medium • If natural gas is used High • If Hydrogen is used produced from renewable energy source (future technology)	1	• High investments • If natural gas is used, low generation costs		
5	Pellet boiler (emission optimised) w/ solar thermal for domestic hot water	Biomass pellets/ solar energy	All typical domestic heating systems	Typical: 10-32 Available: <= 100 kW	Rural residential buildings to replace bulk coal or natural gas.	typ. <250, larger available		5	Low direct emissions • due to homogenous fuel. Also, filter devices are available to further reduce emissions. Combination w/ solar collector allows switching system off in summer.	High • Biomass is GHG neutral when harvested from sustainable forestry	3	• Pellets need to be filled in with bags due to logistics and quality control of the pellets.	In the Market incentive program, Germany gives a special subsidy to emission reducing technologies.	applicable for China
6	Pellet boiler (emission optimised) with PV space heating and domestic hot water	Biomass pellets / PV-electricity	All typical domestic heating systems	Typical: 10-32 Available: <= 100 kW	Rural residential buildings to replace bulk coal or natural gas.	typ. <250, larger available		3	Low direct emissions • due to homogenous fuel. Also, filter devices are available to further reduce emissions. Combination w/ solar collector allows switching system off in summer.	High • Biomass is GHG neutral when harvested from sustainable forestry	3	• Pellets need to be filled in with bags due to logistics and quality control of the pellets. • PV installations have a lower solar gain per m ² than solar thermal installations • PV can be used for household electricity (appliances) and for loading thermal storage if there is no electricity consumption • PV-Heat with thermal storage increases usable renewable energy production without a (more expensive) battery storage		
7	Bio-hybrid heat pump with solid biomass boiler for peak hours	Biomass	All typical domestic heating systems	Typical: 6-34 Available: <= 100 kW	Existing residential buildings with no or only moderate	typ. <250, larger available		2	Direct emissions only on cold days. • They are strongly dependent on	High • due to combination of biomass and highly efficient use of	1	• Low strain of the power supply system. • Extra cost for the installation of the boiler.		

Nb	Technology Name	Heat source	Supply Temperature [°C]	Capacity range [kWthermal]	Main application	Typical heated surface area [m²]	Further technical data	Level of diffusion in German market [1: only single application, 5: widely applied]	Air pollution	Contribution GHG reduction	Cost attractiveness [1: high heat generatio costs due to investment or fuel cost, ... 5: low heat costs = very attractive]	Strengths and Weaknesses	Further remarks	Suggestion
					modernisation of the insulation.				quality of the biomass boiler. A filter can reduce these emissions significantly.	electricity. Depending on share of heat pump.		<ul style="list-style-type: none"> Use of scarce wood resources. Low GHG emissions. 		
8	Heat pump with Ice Storage and solar/air absorber (+PV)	Ambient heat/ electricity	70 Optimal efficiency below 40	6.7-17.2 (Today on the market as packages)	Residential buildings (<250 m²). Best suited for well insulated houses with floor heating. --> Combination of heat pump and insulation	typ. <250, larger available		2	No direct emissions <ul style="list-style-type: none"> as electricity and environmental heat are used as fuel and heat source. Indirect emissions depends on the power generation. 	Medium - High <ul style="list-style-type: none"> The effect depends on power generation. Compared to fossil-fired heating, CO2 savings up to 63% can be achieved (German Energy mix). 	2	<ul style="list-style-type: none"> Cooling of the solar absorber enables to generate up to 30% more energy. Ice from the ice storage can be used for house cooling. Additional investments needed for solar absorber and storage 		
9	Intelligent hybrid system heat pump, wood log boiler, PV, solarthermal	Ambient heat/electricity/ biomass	All typical domestic heating systems	Typical: 6-34 Available: <= 100 kW	Residential buildings (<250 m²).	typ. <250, larger available		2	Low direct emissions	High	2	<ul style="list-style-type: none"> Optimal combination and integration of decentralised RES technologies and its individual strengths Higher investments due to different technologies 	applicable for China	
Local District Heat (DH)														
10	Biogas CHP from manure (DH)	Manure	Typical 2nd/3rd DH: 80 - 120	50 kWth - 1000 kWth	Rural villages	Many buildings		5	Low emissions <ul style="list-style-type: none"> Replacement of decentral oil, coal or gas boilers by central use of energy from biomass. The purification of flue gases in heating centrals is by far more effective than in decentral boilers. 	High <ul style="list-style-type: none"> Decentral coal, oil or gas boilers are replaced by a central plant with no net emissions of CO2. 	5	<ul style="list-style-type: none"> Fast transformation from fossil to renewable fuels. Heat losses of the DH network. Feed-in tariff for renewable electricity or other support increases economic feasibility. 	4.000 CHP plants	
11	Waste water heat pump system (DH)	Waste water	Typical 3rd/4th DH: 80 - 90	50 kWel/50 kWthermal	City districts	Many buildings		5	Low local emissions <ul style="list-style-type: none"> because main energy used is electricity with high efficiency. 	Medium - High <ul style="list-style-type: none"> Low GHG emissions because of the use of the elevated temperature of municipal waste water. 	4	<ul style="list-style-type: none"> Use of waste water as energy source. Additional peak load boilers are needed. Heat generation depends on temperal availability of waste water 	Example: Stuttgart-Neckarpark and some 100 comparable but smaller installations	applicable for China
12	Gas CHP with electric heat pump (DH)	Gas	Typical 2nd/3rd DH: 80 - 120	10.000	Small district heating network	Many buildings	COP = 4.0	2	Lower emissions compared to solid fuel	Medium <ul style="list-style-type: none"> GHG mitigation due to reduced consumption of natural gas, feed in of excess CHP electricity into the grid and high efficiency of heat pump. 	5	<ul style="list-style-type: none"> Very flexible reaction to changing electricity prices. High efficiency High investment in CHP and heat pump. Additional peak load boilers needed. 		
13	Cold DH with decentralized heat pumps (SGDHC)	Ambient / geothermal heat/ electricity	5-20 with decentralised post-heating	100-10000	District heating with decentral substation	Many buildings		1	No direct emissions <ul style="list-style-type: none"> because electricity from the grid is used for driving the heat pump. 	Medium - High <ul style="list-style-type: none"> Dependent on GHG factor of electricity from the grid in comparison to the emissions of the decentral boilers that are replaced. 	1	<ul style="list-style-type: none"> Allows recovering low-temperature excess heat, bi-directionality, modularity, flexibility, low thermal losses. Higher CAPEX than central large heat pump, low delta T, higher pumping costs, electricity costs for HPs 	Integration with many other heat sources, e. g. solar thermal is possible	
14	Biomass boiler with solar thermal incl. seasonal storage	Biomass	Typical 3rd/4th DH: 70-100	typ. 4000	Small district heating network	Many buildings		3	Low emissions <ul style="list-style-type: none"> Improves efficiency of biomass plant and reduces the usage of biomass 	High <ul style="list-style-type: none"> Possibility to shut off boiler in summer. 	4	<ul style="list-style-type: none"> Avoid start up and shut down of biomass boilers or partial load operation. It can replace backup fossil fuel systems used in summer. Local availability of biomass and area for solar collectors required 		applicable for China
Existing Large DH (transformation)														

Nb	Technology Name	Heat source	Supply Temperature [°C]	Capacity range [kWthermal]	Main application	Typical heated surface area [m²]	Further technical data	Level of diffusion in German market [1: only single application, 5: widely applied]	Air pollution	Contribution GHG reduction	Cost attractiveness [1: high heat generatio costs due to investment or fuel cost, ... 5: low heat costs = very attractive]	Strengths and Weaknesses	Further remarks	Suggestion
15	Large heat pump	Lake, river, sea, sewage, ice, geothermal	10-80	1.000-25.000	District heating	Many buildings		2	No direct emissions • because electricity from the grid is used for driving the heat pump.	Medium - High • Dependent on GHG factor of electricity from the grid in comparison to the emissions of the decentral boilers that are replaced.	4	<ul style="list-style-type: none"> Higher efficiency than decentral heat pumps at same operation temperatures. High flow temperatures in DH required to satisfy the needs of the customer with highest heat load. Appropriate heat source necessary. 	Depends highly on electricity price. ca. 150 installations located mainly in Scandinavia. In Germany a few installations.	
16	Large solarthermal collector field (DH)	Sun	70-90	1.000 to 200.000 m2 collector area	Small cities with rural surroundings	Many buildings		2	No direct emissions • CHP, gas and oil boilers in the heating central are replaced by emission free solar heat.	High • CHP, gas and oil boilers in the heating central were replaced by GHG free solar heat.	4	<ul style="list-style-type: none"> Economic transformation of fossil to renewable DH. Seasonal balancing of heating demand and solar supply. Large area is necessary for the installation of the collectors. 	Development starting rapidly in Germany. Denmark has more experience.	applicable for China
17	Geothermal district heating	Geothermal heat	120-150	Large range. Example: el.: 3.000 th.: 38.000	District heating	Many buildings		5	No direct emissions • CHP, gas and oil boilers in the heating central replaced by emission free geothermal heat.	High	2	<ul style="list-style-type: none"> Local and flexible renewable energy that can provide constant base load. Capital intensive and favourable geothermal conditions are needed. Electricity consumption for pumps. 	more than 240 installations in Europe, mostly in France and Germany	applicable for China
18	Combined heating and cooling grid with Gas CHP, heat pumps and thermal storages	Lake, river, sea, sewage, ice, geothermal, electricity	10-80	Combinations of different technologies	District heating	Many buildings		1	Low direct emissions • Depending on Technology combination	High	3	<ul style="list-style-type: none"> Provision of cold and heat and optimal usage of heat for cooling with electric heat pump Highly flexible system for integration of heat/ cold market with electricity market due to heat pumps CHP and thermal storage Increased Economic efficiency of heat pump Additional investments for cooling grid is required 	Example: City of Helsinki	applicable for China
19	Industrial excess heat recovery	Any industrial excess heat source with temperatures above 80 °C	100-200	Large range	District heating	Many buildings		5	No direct emissions	High	5	<ul style="list-style-type: none"> Higher industrial energy efficiency (5% in this case), indepence from primary energy prices. Dependency on excess heat company. 		applicable for China
20	Gas CHP with RES methane (Power-to-gas)	Gas produced from renewable electricity --> Hydrogen --> Methane	Typical 2nd/3rd DH: 80 - 120	Typical Gas CHP: 50kWel - 2000KWel	District heating	Many buildings		1	Lower emissions compared to solid fuel	High	1	<ul style="list-style-type: none"> high investments in electrolyzer and methanisation high generation costs due to low overall efficiency of process still in demonstration phase 		

Website



Wechat

